

HP 3852A Data Acquisition/Control Unit

**HP 44705A, 44705H, 44706A, 44708A, 44708H
Relay Multiplexer Accessories**

Configuration and Programming Manual

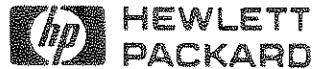

©Copyright Hewlett-Packard Company 1986
Loveland Instrument Division
P.O. Box 301, Loveland, Colorado 80539

Manual Part Number: 44705-90001
Microfiche Part Number: 44705-99001

Printed: NOVEMBER 1986 Edition 1
Printed in Singapore E1186

Printing History

New editions are complete revisions of the manual. Update packages, which are issued between editions, contain additional and replacement pages to be merged into the manual by the customer. The dates on the title page change only when a new edition or a new update is published. No information is incorporated into a reprinting unless it appears as a prior update; the edition does not change when an update is incorporated.

Many product updates and fixes do not require manual changes and, conversely, manual corrections may be done without accompanying product changes. Therefore, do not expect a one-to-one correspondence between product updates and manual updates.

Edition 1.....NOVEMBER 1986

RESTRICTED RIGHTS LEGEND

Use, duplication, or disclosure by the Government is subject to restrictions as set forth in subdivision (b)(3)(ii) of the Rights in Technical Data and Computer Software clause at 52.227-7013.

Hewlett-Packard Company
3000 Hanover Street, Palo Alto, California 94304

NOVEMBER 1986



**HEWLETT
PACKARD**

Herstellerbescheinigung

Hiermit wird bescheinigt, daß das Gerät/System HP 3852A
in Übereinstimmung mit den Bestimmungen von Postverfügung 1046/84 funkentstört ist.

Der Deutschen Bundespost wurde das Inverkehrbringen dieses Gerätes/Systems angezeigt und die Berechtigung zur Überprüfung der Serie auf Einhaltung der Bestimmungen eingeräumt.

Zusatzinformation für Meß- und Testgeräte

Werden Meß- und Testgeräte mit ungeschirmten Kabeln und/oder in offenen Meßaufbauten verwendet, so ist vom Betreiber sicherzustellen, daß die Funk-Entstörbestimmungen unter Betriebsbedingungen an seiner Grundstücksgrenze eingehalten werden.

Manufacturer's declaration

This is to certify that the equipment HP 3852A
is in accordance with the Radio Interference Requirements of Directive FTZ 1046/84. The German Bundespost was notified that this equipment was put into circulation, the right to check the series for compliance with the requirements was granted.

Additional Information for Test- and Measurement Equipment

If Test- and Measurement Equipment is operated with unshielded cables and/or used for measurements on open set-ups, the user has to assure that under operating conditions the Radio Interference Limits are still met at the border of his premises.

NOTICE

The information contained in this document is subject to change without notice.

HEWLETT-PACKARD MAKES NO WARRANTY OF ANY KIND WITH REGARD TO THIS MATERIAL, INCLUDING, BUT NOT LIMITED TO, THE IMPLIED WARRANTIES OF MERCHANTABILITY AND FITNESS FOR A PARTICULAR PURPOSE. Hewlett-Packard shall not be liable for errors contained herein or for incidental or consequential damages in connection with the furnishing, performance or use of this material.

Hewlett-Packard assumes no responsibility for the use or reliability of its software on equipment that is not furnished by Hewlett-Packard.

This document contains proprietary information which is protected by copyright. All rights are reserved. No part of this document may be photocopied, reproduced or translated to another language without the prior written consent of Hewlett-Packard Company.

Copyright © 1985 by HEWLETT-PACKARD COMPANY



**HEWLETT
PACKARD**

CERTIFICATION

Hewlett-Packard Company certifies that this product met its published specifications at the time of shipment from the factory. Hewlett-Packard further certifies that its calibration measurements are traceable to the United States National Bureau of Standards, to the extent allowed by the Bureau's calibration facility, and to the calibration facilities of other International Standards Organization members.

WARRANTY

This Hewlett-Packard instrument product is warranted against defects in materials and workmanship for a period of one year from date of shipment. During the warranty period, Hewlett-Packard Company will, at its option, either repair or replace products which prove to be defective.

For warranty service or repair, this product must be returned to a service facility designated by -hp-. Buyer shall prepay shipping charges to -hp- and -hp- shall pay shipping charges to return the product to Buyer. However, Buyer shall pay all shipping charges, duties, and taxes for products returned to -hp- from another country.

Duration and conditions of warranty for this instrument may be superceded when the instrument is integrated into (becomes a part of) other -hp- instrument products.

Hewlett-Packard warrants that its software and firmware designated by -hp- for use with an instrument will execute its programming instructions when properly installed on that instrument. Hewlett-Packard does not warrant that the operation of the instrument, or software, or firmware will be uninterrupted or error free.

LIMITATION OF WARRANTY

The foregoing warranty shall not apply to defects resulting from improper or inadequate maintenance by Buyer, Buyer-supplied software or interfacing, unauthorized modification or misuse, operation outside of the environmental specifications for the product, or improper site preparation or maintenance.

NO OTHER WARRANTY IS EXPRESSED OR IMPLIED. HEWLETT-PACKARD SPECIFICALLY DISCLAIMS THE IMPLIED WARRANTIES OF MERCHANTABILITY AND FITNESS FOR A PARTICULAR PURPOSE.

EXCLUSIVE REMEDIES

THE REMEDIES PROVIDED HEREIN ARE BUYER'S SOLE AND EXCLUSIVE REMEDIES. HEWLETT-PACKARD SHALL NOT BE LIABLE FOR ANY DIRECT, INDIRECT, SPECIAL, INCIDENTAL, OR CONSEQUENTIAL DAMAGES, WHETHER BASED ON CONTRACT, TORT, OR ANY OTHER LEGAL THEORY.

ASSISTANCE

Product maintenance agreements and other customer assistance agreements are available for Hewlett-Packard products.

For any assistance, contact your nearest Hewlett-Packard Sales and Service Office. Addresses are provided at the back of this manual.



**HEWLETT
PACKARD**

SAFETY SUMMARY

The following general safety precautions must be observed during all phases of operation, service, and repair of this instrument. Failure to comply with these precautions or with specific warnings elsewhere in this manual violates safety standards of design, manufacture, and intended use of the instrument. Hewlett-Packard Company assumes no liability for the customer's failure to comply with these requirements.

GROUND THE INSTRUMENT

To minimize shock hazard, the instrument chassis and cabinet must be connected to an electrical ground.

DO NOT OPERATE IN AN EXPLOSIVE ATMOSPHERE

Do not operate the instrument in the presence of flammable gases or fumes. Operation of any electrical instrument in such an environment constitutes a definite safety hazard.

KEEP AWAY FROM LIVE CIRCUITS

Operating personnel must not remove instrument covers. Component replacement and internal adjustments must be made by qualified maintenance personnel. Under certain conditions, dangerous voltages may exist even with the instrument switched off. To avoid injuries, always disconnect input voltages and discharge circuits before touching them.

DO NOT SERVICE OR ADJUST ALONE

Do not attempt internal service or adjustment unless another person, capable of rendering first aid and resuscitation, is present.

DO NOT SUBSTITUTE PARTS OR MODIFY INSTRUMENT









Because of the danger of introducing additional hazards, do not install substitute parts or perform any unauthorized modification to the instrument. Return the instrument to a Hewlett-Packard Sales and Service Office for service and repair to ensure that safety features are maintained.

DO NOT OPERATE A DAMAGED INSTRUMENT

Whenever it is possible that the safety protection features built into this instrument have been impaired, either through physical damage, excessive moisture, or any other reason, REMOVE POWER and do not use the instrument until safe operation can be verified by service-trained personnel. If necessary, return the instrument to a Hewlett-Packard Sales and Service Office for service and repair to ensure that safety features are maintained.

Operating and Safety Symbols

Symbols Used On Products And In Manuals

	LINE	AC line voltage input receptacle.
		Instruction manual symbol affixed to product. Warns and cautions the user to refer to respective instruction manual procedures to avoid personal injury or possible damage to the product.
		Indicates dangerous voltage – terminals connected to interior voltage exceeding 1000 volts.
	OR	
		Protective conductor terminal. Indicates the field wiring terminal that must be connected to earth ground before operating equipment – protects against electrical shock in case of fault.
		Clean ground (low-noise). Indicates terminal that must be connected to earth ground before operating equipment – for single common connections and protection against electrical shock in case of fault.
	OR	
		Frame or chassis ground. Indicates equipment chassis ground terminal – normally connects to equipment frame and all metal parts.
		Affixed to product containing static sensitive devices – use anti-static handling procedures to prevent electrostatic discharge damage to components.

NOTE

NOTE *Calls attention to a procedure, practice, or condition that requires special attention by the reader.*

CAUTION

CAUTION *Calls attention to a procedure, practice, or condition that could possibly cause damage to equipment or permanent loss of data.*





WARNING

WARNING *Calls attention to a procedure, practice, or condition that could possibly cause bodily injury or death.*

WARNING, CAUTION, and NOTE Symbols

Some labels on the HP 3852A, HP 3853A, and plug-in accessories include an international warning symbol (triangle with subscripted number) which refers the reader to the manuals for further information. This table shows the warning symbols used for the HP 3852A/3853A and plug-in accessories. Refer to the manual set for specific information on WARNINGS, CAUTIONS, or NOTES referenced with a warning symbol.

HP 3852A WARNING, CAUTION, and NOTE Symbols

Symbol	Meaning	Location
	Shock hazard originating outside the instrument (field wiring)	<ul style="list-style-type: none"> . Analog Extender Connector on Power Supply Modules . Terminal modules on plug-in accessories . Component module covers on plug-in accessories
	Treat all channels as "one circuit" for safety purposes.	<ul style="list-style-type: none"> . Inside terminal modules on plug-in accessories . Metal cover on component modules of plug-in accessories
	Maximum number of certain plug-in accessories to be installed into an HP 3852A or HP 3853A.	<ul style="list-style-type: none"> . HP 44701A, HP 44702A/B, HP 44727A/B/C plug-in accessories
	If High-Speed FET multiplexers are used with the HP 44702A/B, ribbon cable may be connected.	<ul style="list-style-type: none"> . HP 44711A, 44712A, 44713A (referenced on HP 44702A and HP 44702B)

1
2
3
4
5
6
7
8
9
10
11
12
13
14
15
16
17
18
19
20
21
22
23
24
25
26
27
28
29
30
31
32
33
34
35
36
37
38
39
40
41
42
43
44
45
46
47
48
49
50
51
52
53
54
55
56
57
58
59
60
61
62
63
64
65
66
67
68
69
70
71
72
73
74
75
76
77
78
79
80
81
82
83
84
85
86
87
88
89
90
91
92
93
94
95
96
97
98
99
100

TABLE OF CONTENTS

CHAPTER 1 - INTRODUCTION

Manual Contents.....	1-1
Multiplexer Descriptions.....	1-2
Multiplexer Functions.....	1-4
Getting Started.....	1-6
Define Your Application.....	1-6
Configure the Multiplexer.....	1-6
Program the Multiplexer.....	1-6

Chapter 2 - CONFIGURING THE HP 44705A/44705H



1, 2

Configuration Overview.....	2-1
Warnings and Cautions.....	2-1
Block Diagram Description.....	2-4
Terminal Module Configuration.....	2-7
Isolation Jumper.....	2-7
Low-Pass Filters.....	2-8
Attenuators.....	2-8
Current Sensing.....	2-8
Field Wiring Connections.....	2-8
Terminal Module Connections.....	2-12
Voltage Measurements Connections.....	2-13
Resistance Measurements Connections.....	2-14
2-Wire Ohms Connections.....	2-14
4-Wire Ohms Connections.....	2-17
Temperature Measurements Connections.....	2-19
RTD Connections.....	2-19
Thermistor Connections.....	2-19
Installation/Checkout.....	2-20
Check Accessory ID.....	2-20
Verify Wiring Connections.....	2-21
Read Channel State.....	2-21

Chapter 3 - CONFIGURING THE HP 44706A



1, 2

Configuration Overview.....	3-1
Warnings and Cautions.....	3-1
Block Diagram Description.....	3-2
Field Wiring Connections.....	3-5
Terminal Module Connections.....	3-5
Voltage Measurements Connections.....	3-6
Resistance Measurements Connections.....	3-9
Installation/Checkout.....	3-11
Check Accessory ID.....	3-11
Verify Wiring Connections.....	3-12
Read Channel State.....	3-12

TABLE OF CONTENTS (Cont'd)

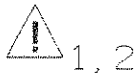

Chapter 4 - CONFIGURING THE HP 44708A/44708H

Configuration Overview.....	4-1
Warnings and Cautions.....	4-1
Block Diagram Description.....	4-4
Terminal Module Configuration.....	4-7
Isolation Jumper.....	4-7
Low-Pass Filters.....	4-8
Attenuators.....	4-10
Current Sensing.....	4-11
Field Wiring Connections.....	4-13
Terminal Module Connections.....	4-13
Voltage Measurements Connections.....	4-14
Resistance Measurements Connections.....	4-15
Thermocouple Connections.....	4-18
Installation/Checkout.....	4-20
Check Accessory ID.....	4-20
Verify Wiring Connections.....	4-21
Read Channel State.....	4-21

Chapter 5 - PROGRAMMING THE MULTIPLEXERS

Programming Overview.....	5-1
Chapter Contents.....	5-1
Command Summary.....	5-2
Program Titles.....	5-2
Voltage Measurements.....	5-3
Current Measurements.....	5-7
Resistance Measurements.....	5-9
2-Wire Ohms Measurements.....	5-9
4-Wire Ohms Measurements.....	5-11
Temperature Measurements.....	5-12
RTD Measurements.....	5-12
Thermistor Measurements.....	5-13
Thermocouple Measurements.....	5-14

Index.....	I-1
------------	-----

Chapter 1

Introduction

Contents

Manual Contents.....	1-1
Multiplexer Descriptions.....	1-2
Multiplexer Functions.....	1-4
Getting Started.....	1-6
Define Your Application.....	1-6
Configure the Multiplexer.....	1-6
Program the Multiplexer.....	1-6

Manual Contents

This manual shows how to configure and program five HP 3852A accessory relay multiplexers:

- HP 44705A 20-Channel Relay Multiplexer
- HP 44705H 20-Channel High-Voltage Relay Multiplexer
- HP 44706A 60-Channel Single-Ended Relay Multiplexer
- HP 44708A 20-Channel Relay Multiplexer/Thermocouple Compensation
- HP 44708H 20-Channel High-Voltage Relay Multiplexer/Thermocouple Compensation.

In this manual, each multiplexer is referred to by its product number (HP 44705A, HP 44708H, etc). Refer to the HP 3852A Mainframe Configuration and Programming Manual for additional information on the accessories. The manual has five chapters: Introduction, Configuring the HP 44705A/44705H, Configuring the HP 44706A, Configuring the HP 44708A/44708H, and Programming the Multiplexers.

- **Introduction** contains a manual overview, summarizes multiplexer descriptions and functions, and shows suggested steps to get started.
- **Configuring the HP 44705A/44705H** contains a block diagram description of the HP 44705A and HP 44705H multiplexers, shows how to hardware configure terminal modules, and shows how to connect field wiring to the terminal modules.
- **Configuring the HP 44706A** contains a block diagram description of the HP 44706A multiplexer and shows how to connect field wiring to the terminal module.
- **Configuring the HP 44708A/44708H** contains a block diagram description of the HP 44708A and HP 44708H multiplexers, shows how to hardware configure terminal modules, and shows how to connect field wiring to the terminal modules.
- **Programming the Multiplexers** shows how to program the accessories for voltage, current, resistance, and temperature measurements, as applicable to the accessory.

Multiplexer Descriptions

The multiplexer accessories are used to switch (multiplex) signals from up to 20 inputs (HP 44705A/44705H/44708A/44708H) or up to 60 inputs (HP 44706A only) to the analog backplane bus for measurements by HP 3852A voltmeter accessories or by external voltmeters. A description of each multiplexer follows.

HP 44705A 20-Channel Relay Multiplexer

The HP 44705A is an analog signal multiplexer used to switch (multiplex) signals from up to 20 inputs for measurement by HP 3852A voltmeter accessories or by external voltmeters. This accessory provides switching capability for up to 20 inputs at switching rates up to 450 channels/second using HP 3852A voltmeters. The accessory can switch signals up to 170 VDC or 120 VAC rms (170 V peak).

The HP 44705A consists of a component module and a 20-channel terminal module. Field wiring from user sources (such as voltage sources) is connected to the terminal module and signals are sent to the switches on the component module. Each channel on the HP 44705A can be independently configured to allow multiple functions to be measured using the same accessory.

HP 44705H 20-Channel High Voltage Relay Multiplexer

The HP 44705H is an analog signal multiplexer used to switch (multiplex) signals from up to 20 inputs for measurement by HP 3852A voltmeter accessories or by external voltmeters. This accessory provides switching capability for up to 20 inputs at scanning speeds up to 250 channels/second using HP 3852A voltmeters. The accessory can switch signals up to 200 VDC or 250 VAC rms (354V peak).

The HP 44705H consists of a component module (the same as the HP 44705A component module but with high-voltage relays added) and a 20-channel terminal module (the same as the HP 44705A terminal module). Field wiring from user sources (such as voltage sources) is connected to the terminal module and signals are sent to the switches on the component module. Each channel on the HP 44705H can be independently configured to allow multiple functions to be measured using the same accessory.

HP 44706A 60-Channel Relay Multiplexer

The HP 44706A is an analog signal multiplexer used to switch (multiplex) signals from up to 60 single-ended inputs for measurement by HP 3852A voltmeter accessories or by external voltmeters. This accessory provides switching capability for up to 60 single-ended inputs at switching rates up to 450 channels/second using HP 3852A voltmeters. The accessory can switch signals up to 42 VDC or 30 VAC rms (42V peak).

The HP 44706A consists of a component module and a 60-channel terminal module. Field wiring from user sources (such as voltage sources) is connected to the terminal module and signals are sent to the switches on the component module. Each channel on the HP 44706A can be independently configured to allow multiple functions to be measured using the same accessory.

HP 44708A 20-Channel Relay Multiplexer/TC

The HP 44708A is an analog signal multiplexer used to switch (multiplex) signals from up to 20 inputs for measurement by HP 3852A voltmeter accessories or by external voltmeters. This accessory provides switching capability for up to 20 inputs at switching rates up to 450 channels/second using HP 3852A voltmeters. The accessory can switch signals up to 170 VDC or 120 VAC rms (170V peak).

The HP 44708A consists of a component module and a 20-channel terminal module. The HP 44708A uses the same component module as the HP 44705A. A special isothermal connector block on the terminal module provides the reference junction for thermocouple measurements. A thermistor mounted on the isothermal connector block is used to measure the isothermal block reference temperature. The HP 3852A uses software compensation to automatically compensate for the reference temperature when making thermocouple measurements.

Field wiring from user sources (such as voltage sources) is connected to the terminal module and signals are sent to the switches on the component module. Each channel on the HP 44708A can be independently configured to allow multiple functions to be measured using the same accessory.

HP 44708H 20-Channel High-Voltage Relay Multiplexer/TC

The HP 44708H is an analog signal multiplexer used to switch (multiplex) signals from up to 20 inputs for measurement by HP 3852A voltmeter accessories or by external voltmeters. This accessory provides switching capability for up to 20 inputs at switching rates up to 250 channels/second using HP 3852A voltmeters. The accessory can switch signals up to 200 VDC or 250 VAC rms (354V peak).

The HP 44708H consists of a component module and a 20-channel terminal module. The HP 44708H uses the same component module as the HP 44705H. A special isothermal connector block on the terminal module provides the reference junction for thermocouple measurements. A thermistor mounted on the isothermal connector block is used to measure the isothermal block reference temperature. The HP 3852A uses software compensation to automatically compensate for the reference temperature when making thermocouple measurements.

Field wiring from user sources (such as voltage sources) is connected to the terminal module and signals are sent to the switches on the component module. Each channel on the HP 44708H can be independently configured to allow multiple functions to be measured using the same accessory.

Multiplexer Functions

The multiplexer accessories can be used to switch signals for four measurement functions: voltage, current, resistance, or temperature. Each channel can be independently configured to allow multiple functions to be measured using the same accessory. Table 1-1 summarizes recommended measurement functions for the five multiplexers.

Table 1-1. Primary Multiplexer Measurements/Applications

Multiplexer	Recommended Measurements	Primary Applications
HP 44705A	<ul style="list-style-type: none"> . AC/DC Voltage [1] . AC/DC Current [2] . 2-Wire Ohms . 4-Wire Ohms . RTDs [3] . Thermistors [4] 	<ul style="list-style-type: none"> . Guarded measurements . Up to 20 inputs . Up to 450 channels/sec . Max input 170 VDC or 120 VAC rms (170 V peak)
HP 44705H	<ul style="list-style-type: none"> . AC/DC Voltage [1] . AC/DC Current [2] . 2-Wire Ohms . 4-Wire Ohms . RTDs [3] . Thermistors [4] 	<ul style="list-style-type: none"> . Guarded measurements . Up to 20 inputs . Up to 250 channels/sec . Max input 200 VDC or 250 VAC rms (354 V peak)
HP 44706A	<ul style="list-style-type: none"> . AC/DC Voltage [1] . 2-Wire Ohms [5] 	<ul style="list-style-type: none"> . Single-ended measurements . Up to 60 inputs . Up to 450 channels/sec . Max input 42 VDC or 30 VAC rms (42 V peak)
HP 44708A	<ul style="list-style-type: none"> . AC/DC Voltage [1] . AC/DC Current [2] . 2-Wire Ohms [5] . Thermocouples [6] 	<ul style="list-style-type: none"> . Thermocouple measurements . Up to 20 inputs . Up to 450 channels/sec . Max input 170 VDC or 120 VAC rms (170 V peak)
HP 44708H	<ul style="list-style-type: none"> . AC/DC Voltage [1] . AC/DC Current [2] . 2-Wire Ohms [5] . Thermocouples [6] 	<ul style="list-style-type: none"> . Thermocouple measurements . Up to 20 inputs . Up to 250 channels/sec . Max input 200 VDC or 250 VAC rms (354 V peak)

Notes:

[1] = With HP 44702A/B High-Speed Voltmeter, can only make DC voltage measurements.

[2] = Requires installation of resistor on terminal module. With HP 44702A/B High-Speed Voltmeter, can only make DC current measurements.

[3] = 4-wire ohms measurement method recommended. HP 3852A supports Type 85 ($\alpha = 0.00385 \Omega/\Omega^{\circ}\text{C}$) and Type 92 ($\alpha = 0.003916 \Omega/\Omega^{\circ}\text{C}$) RTDs.

[4] = 4-wire ohms measurement method recommended. HP 3852A supports Type 2252 (2252 Ω), 5K (5000 Ω), and 10K (10,000 Ω) thermistors.

[5] = Due to potential temperature measurement errors with 2-wire ohms measurements, RTD and thermistor measurements are not recommended for the HP 44706A, HP 44708A, and HP 44708H multiplexers.

[6] = HP 3852A conversion program applicable only to B, E, J, K, N14 (AWG 14), N28 (AWG 28), R, S, and T types. Other thermocouples can be measured with user supplied temperature conversion program.

Getting Started

To use a multiplexer accessory for your application, you will need to do three things:

- Define your application.
- Configure multiplexer.
- Program the multiplexer.

Define Your Application

The first step is to define your application and select the multiplexer for the requirements of your application. When selecting devices to be connected, refer to the Specifications appendix in the HP 3852A Mainframe Configuration and Programming Manual to ensure that the voltage and current requirements of your application are within the specifications for the accessory.

Configure the Multiplexer

The next step is to configure the multiplexer for your application. Refer to Table 1-1 for a list of recommended measurements for the accessories.

- If you selected the HP 44705A or HP 44705H multiplexer, refer to Chapter 2 - Configuring the HP 44705A/44705H for information on hardware configuration and connecting field wiring to the terminal modules for voltage, current, resistance, and temperature measurements.
- If you selected the HP 44706A multiplexer, refer to Chapter 3 - Configuring the HP 44706A for information on connecting field wiring to the terminal module for voltage and resistance measurements.
- If you selected the HP 44708A or HP 44708H multiplexer, refer to Chapter 4 - Configuring the HP 44708A/44708H for information on hardware configuration and connecting field wiring to the terminal modules for voltage, current, resistance, and temperature measurements.

Program the Multiplexer

When the multiplexer has been configured for your measurement, the third step is to program the accessory for your application. Refer to Chapter 5 - Programming the Multiplexers to program the accessory for voltage, current, resistance, or temperature measurements.

Chapter 2

Configuring the HP 44705A/44705H

Contents



Configuration Overview.....	2-1
Warnings and Cautions.....	2-1
Block Diagram Description.....	2-4
Terminal Module Configuration.....	2-7
Isolation Jumper.....	2-7
Low-Pass Filters.....	2-8
Attenuators.....	2-8
Current Sensing.....	2-8
Field Wiring Connections.....	2-8
Terminal Module Connections.....	2-12
Voltage Measurements Connections.....	2-13
Resistance Measurements Connections.....	2-14
2-Wire Ohms Connections.....	2-14
4-Wire Ohms Connections.....	2-17
Temperature Measurements Connections.....	2-19
RTD Connections.....	2-19
Thermistor Connections.....	2-19
Installation/Checkout.....	2-20
Check Accessory ID.....	2-20
Verify Wiring Connections.....	2-21
Read Channel State.....	2-21

Configuring the HP 44705A/44705H

Configuration Overview

This chapter shows how to configure the HP 44705A and HP 44705H multiplexer accessories. The chapter contains a block diagram description of the HP 44705A and HP 44705H accessories, shows how to hardware configure the terminal modules, and shows how to connect field wiring to the terminal modules.

When you have configured the multiplexer for your application, refer to Chapter 5 - Programming the Multiplexers to program the accessories for voltage, current, resistance, and temperature measurements.

Warnings and Cautions

This section summarizes the WARNINGS and CAUTIONS which apply to the HP 44705A and HP 44705H multiplexers. You should review the WARNINGS and CAUTIONS shown before configuring the multiplexers.

WARNING



SHOCK HAZARD. Only qualified, service-trained personnel who are aware of the hazards involved should install, remove, or configure any accessory. Before touching any installed accessory, turn off all power to the mainframe, extenders, and to all external devices connected to the mainframe, extenders, or accessories.

WARNING

POSSIBLE OPERATOR INJURY. For safety, consider all accessory channels to be at the highest potential applied to any channel. Under most conditions of failure, the relays on the relay multiplexers will remain in whatever state the program sets them.



However, for some equipment failures, the relays may not remain in their programmed state. If the relays settle in the closed state, the relay contacts may weld together and the highest voltage present on any one channel may be present on all channels. This condition may cause operator injury if the terminals are touched or equipment damage may result.

WARNING

MAXIMUM VOLTAGE LIMITATIONS. The HP 3852A and the HP 3853A internal analog buses interconnect the multiplexer and voltmeter accessories to form one circuit. To protect against possible personal injury due to equipment failure or programming error, limitations are placed on the potentials that can appear between any two points on the circuit (or between the circuit and chassis).



These limitations are listed for the HP 3852A, HP 3853A, and all plug-in accessories. For any given set of accessories installed in the mainframe or extender, the maximum potential between any two points is determined by the accessory with the LOWEST peak voltage limitation, as follows. (If the analog extender cable is NOT connected between the mainframe and the extenders, each instrument is considered as a separate circuit.)

The maximum nondestructive voltage which can be applied to the HP 44705A is 170 VDC or 120 VAC rms (170 V peak). The maximum nondestructive voltage which can be applied to the HP 44705H is 200 VDC or 250 VAC rms (354 V peak).

<i>Instrument/Accessory</i>	<i>Peak Voltage</i>
<i>HP 3852A Mainframe</i>	<i>350 V</i>
<i>HP 3853A Extender</i>	<i>350 V</i>
<i>HP 44701A Integrating Voltmeter</i>	<i>350 V</i>
<i>HP 44702A/B High-Speed Voltmeter</i>	<i>42 V</i>
<i>HP 44705A/08A/17A/18A 20-Channel Relay Multiplexers</i>	<i>170 V</i>
<i>HP 44705H/08H 20-Channel High-Voltage Relay Multiplexers</i>	<i>354 V</i>
<i>HP 44706A 60-Channel Relay Multiplexer</i>	<i>42 V</i>
<i>HP 44709A/10A/11A/12A/13A FET Multiplexers</i>	<i>42 V</i>

CAUTION

POSSIBLE EQUIPMENT DAMAGE. When making high-voltage measurements with the HP 44705A or HP 44705H, the HP 3852A analog backplane becomes charged to the voltage on the last channel connected to it. Thus, the next channel that is closed may have to absorb all of the stored energy on the backplane.

If the backplane is not discharged after making a high-voltage measurement, the voltage present on the backplane must be added to the voltage being switched on the next channel to determine the total relay contact voltage. See Figure 2-1 for guidelines to maximize relay life and prevent damage to sensitive transducers by high backplane discharge voltages.

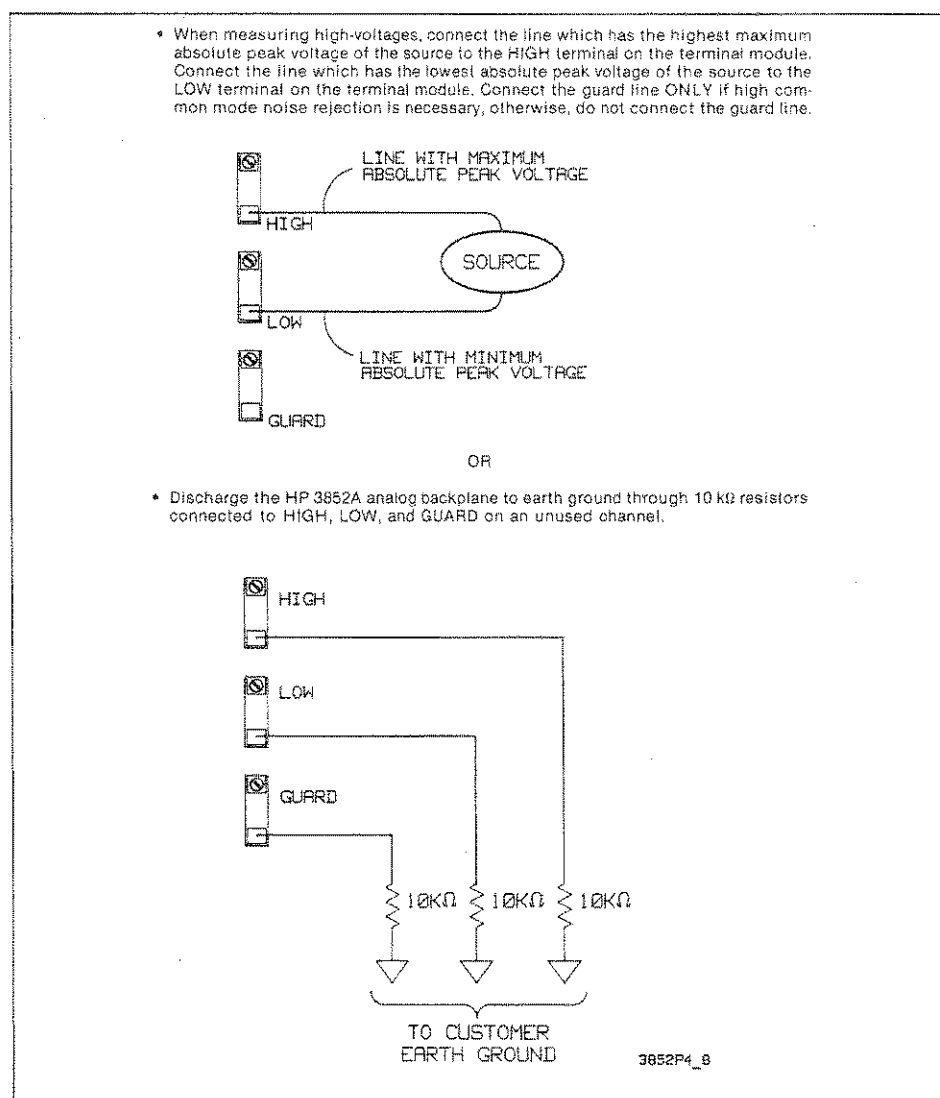

Figure 2-1. Discharging the HP 3852A Backplane

CAUTION

STATIC SENSITIVE. Use clean-handling techniques when handling the accessory. Do not install an accessory without the metal covers attached.

Block Diagram Description

The HP 44705A and HP 44705H accessories consist of a 20-channel terminal module and a component module as shown in Figure 2-2. Field wiring from your application sensors (such as voltage sources) is connected to the terminal module and the signals are sent to the switches located on the component module.

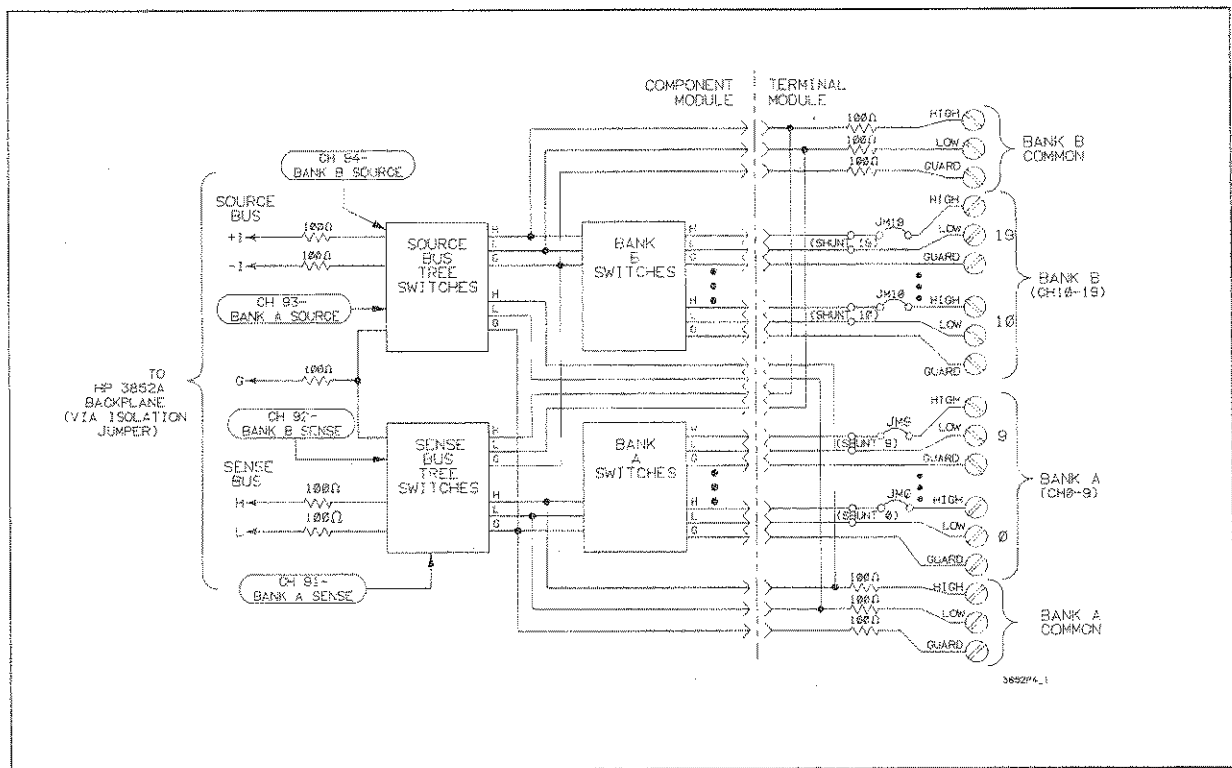

Figure 2-2. HP 44705A/44705H Block Diagram

Component Module

The component module consists of 24 switches which are divided into two categories: bank switches and tree switches. Each of the 24 switches consists of three reed-actuated relays, one each for HIGH, LOW, and GUARD lines. There are 20 bank switches which are divided into two groups of 10 channels each: Bank A and Bank B. The channels in Bank A are numbered 0 through 9 and the channels in Bank B are numbered 10 through 19.

NOTE

Only one channel per bank can be closed at a time. Closing a second channel in a bank will open any previously closed channel in that bank.

The component module contains two types of tree switches: Source Bus and Sense Bus. Each of the two banks has one Source Bus tree switch and one Sense Bus tree switch. The tree switches control signal flow to and from the HP 3852A backplane and also isolate the bank switches from the backplane when they are not in use.

The Sense Bus tree switches provide connections to the backplane to make voltage measurements. The Source Bus tree switches provide backplane connections to the HP 44701A or HP 44702A/B voltmeter current sources (+I and -I) to make resistance measurements.

Five resistors on the component module connect the tree switches to the HP 3852A backplane to provide current limiting protection for the component module relays. The resistors do not affect resistance measurements (2-wire ohms error due to contact and trace resistance is $< 2 \Omega$). These resistors can be shorted out, but this will seriously shorten relay life if high voltages or currents are switched.

The component module also includes an Isolation Jumper which allows you to disconnect the tree switches from the HP 3852A backplane for special signal routing applications. Refer to "Isolation Jumper" for details on setting the Isolation Jumper.

Terminal Module

The terminal module consists of 20 channels of terminal connectors to connect field wiring and a Bank A COMMON and Bank B COMMON connection. The Bank A COMMON and Bank B COMMON terminals on the terminal module can be used to connect an external voltmeter or for diagnostic procedures.

As factory configured, there are three current limiting resistors in series with the Bank A COMMON terminal and three current limiting resistors in series with the Bank B COMMON terminal.

Channel Definitions

Table 2-1 shows the channel definitions for the HP 44705A and HP 44705H accessories. Channels 0 through 19 control the bank switches, channels 91 and 92 control the Sense Bus tree switches, and channels 93 and 94 control the Source Bus tree switches.

When using high-level commands (such as CONFMEAS or MEAS), the appropriate tree switches and bank switches are automatically closed along with the measurement channel by the command. However, when using low-level commands such as OPEN and CLOSE, the appropriate bank and tree switch channels (as defined in Table 2-1) must be specified as well as the measurement channel.

For example, to make voltage measurements on channel 0 using CLOSE, you will need to close the Bank A Sense Bus tree switch (channel 91) and the measurement channel (channel 0). Or, to make voltage measurements on channel 19, close Bank B Sense Bus tree switch (channel 92) and the measurement channel (channel 19).

To make resistance measurements with CLOSE, you will need to close both the Sense Bus and Source Bus tree switches and the measurement channel. For example, to make 2-wire ohms resistance measurements on channel 0, close the Bank A Sense Bus tree switch (channel 91), the Bank A Source Bus tree switch (channel 93) and the measurement channel (channel 0).

Table 2-1. HP 44705A/44705H Channel Definitions

Channel	Definitions
0 - 9	Bank A Switches
10 - 19	Bank B Switches
91	Sense Bus Tree Switch (Bank A)
92	Sense Bus Tree Switch (Bank B)
93	Source Bus Tree Switch (Bank A)
94	Source Bus Tree Switch (Bank B)

Terminal Module Configuration

This section shows how to hardware configure the HP 44705A and HP 44705H terminal modules. It shows how to set the Isolation Jumper, how to install low-pass filters and attenuators on the terminal module for input signal conditioning, and how to install resistors on the terminal module for current sensing applications.

Isolation Jumper

The tree switches on the HP 44705A or HP 44705H multiplexer can be connected or disconnected from the HP 3852A backplane using the Isolation Jumper. Figure 2-3 shows the location of the Isolation Jumper (J1) on the component module.

The jumper has an EN (enable) and DIS (disable) position. For normal operation, the jumper should be in the EN position to connect the tree switches to the backplane. For special applications which require tree switch isolation from the backplane, move the jumper to the DIS position. Factory setting is the EN position.

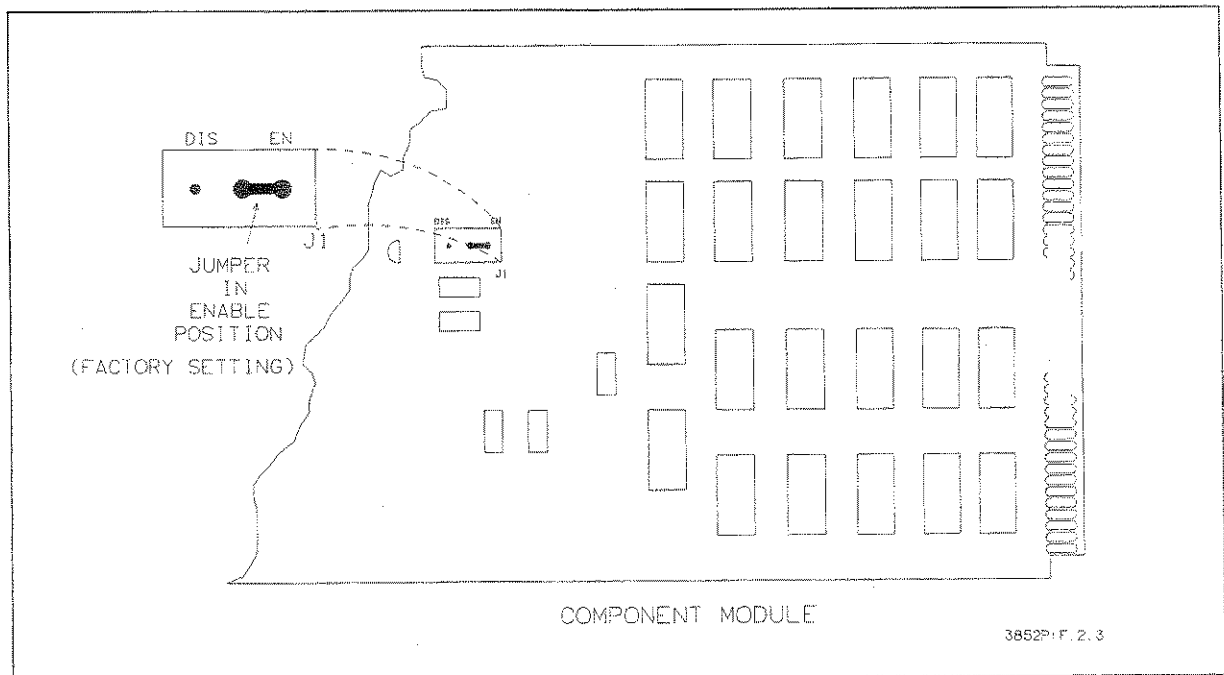

Figure 2-3. HP 44705A/44705H Isolation Jumper Configuration

Low-Pass Filters

Space has been provided on the terminal module for you to install low-pass filters for input signal conditioning on each channel. Figure 2-4 shows normal channel configuration and shows how to install a low-pass filter on channel 10 of the terminal module. To install the low-pass filter, remove the jumper (SERIES JM 10) and install your resistor in its place. Then, install your capacitor in the SHUNT 10 position as shown.

Attenuators

The space for low-pass filters on the terminal module can also be used to install attenuators to reduce input signals to a usable level for the HP 44705A or HP 44705H. Figure 2-5 shows normal channel configuration and shows how to install an attenuator on channel 0 of the terminal module. To install the attenuator, remove the jumper (SERIES JM 0) and install resistor R1 in its place. Then, install resistor R2 in the SHUNT 0 position as shown. Precision components should be used to maintain accuracy.

Current Sensing

The HP 44705A or HP 44705H multiplexers use current sensing to make current measurements. When making a current sensing measurement, the voltage across a shunt resistor is measured and the current is calculated by the controller using the measured voltage and the resistance value of the shunt. Precision resistors should be used to maintain accuracy.

Figure 2-6 shows normal channel configuration and shows how to configure channel 0 for current sensing measurements. In Figure 2-6, a 250 Ω shunt resistor (R0) is installed in the shunt position (BANK A SHUNT 0) for channel 0 on the terminal module. Note that the SERIES JM jumper (JM0 in this example) MUST be in place on the terminal module for each channel being used for current measurements.

Field Wiring Connections

When the terminal module is configured as required, the next step is to connect field wiring from your application to the terminals on the terminal module. This section contains example field wiring connections to the HP 44705A or HP 44705H terminal module for voltage, resistance, and temperature measurements.

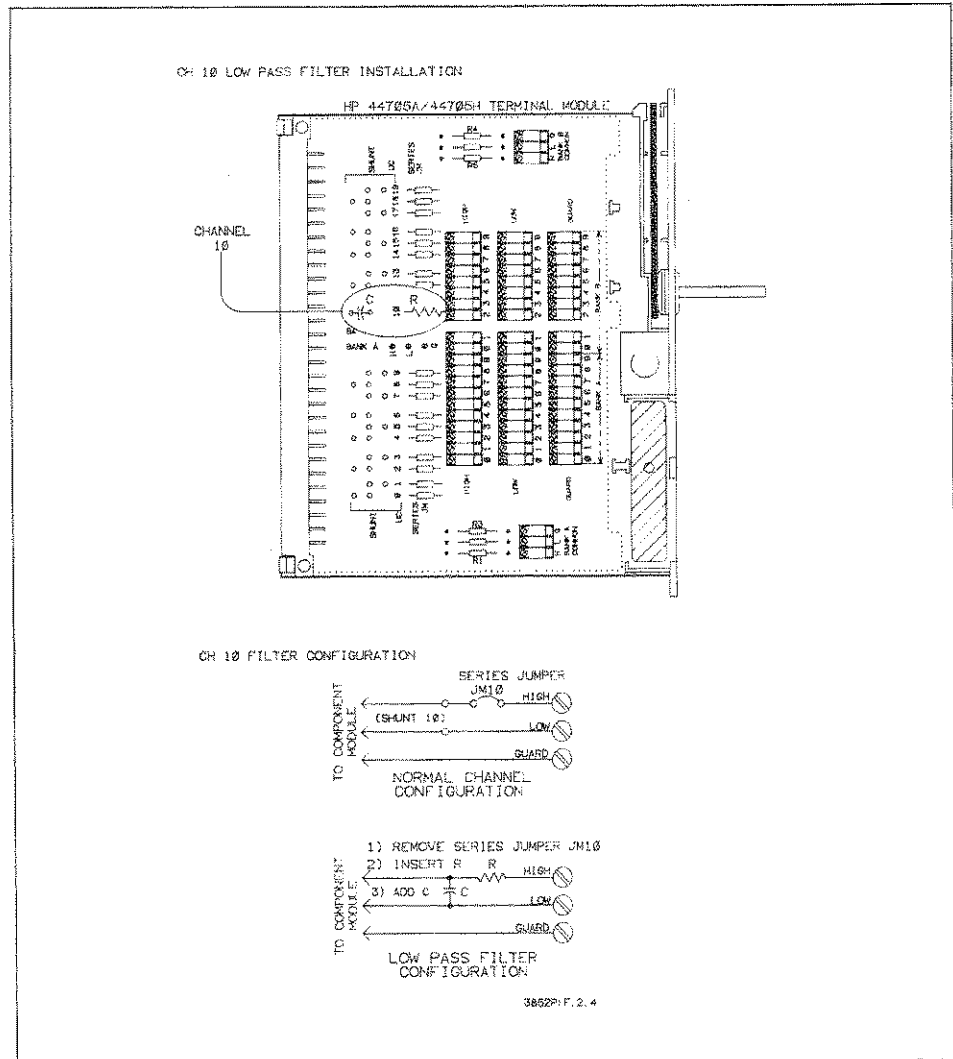

Figure 2-4. HP 44705A/44705H Low-Pass Filter Channel Configuration

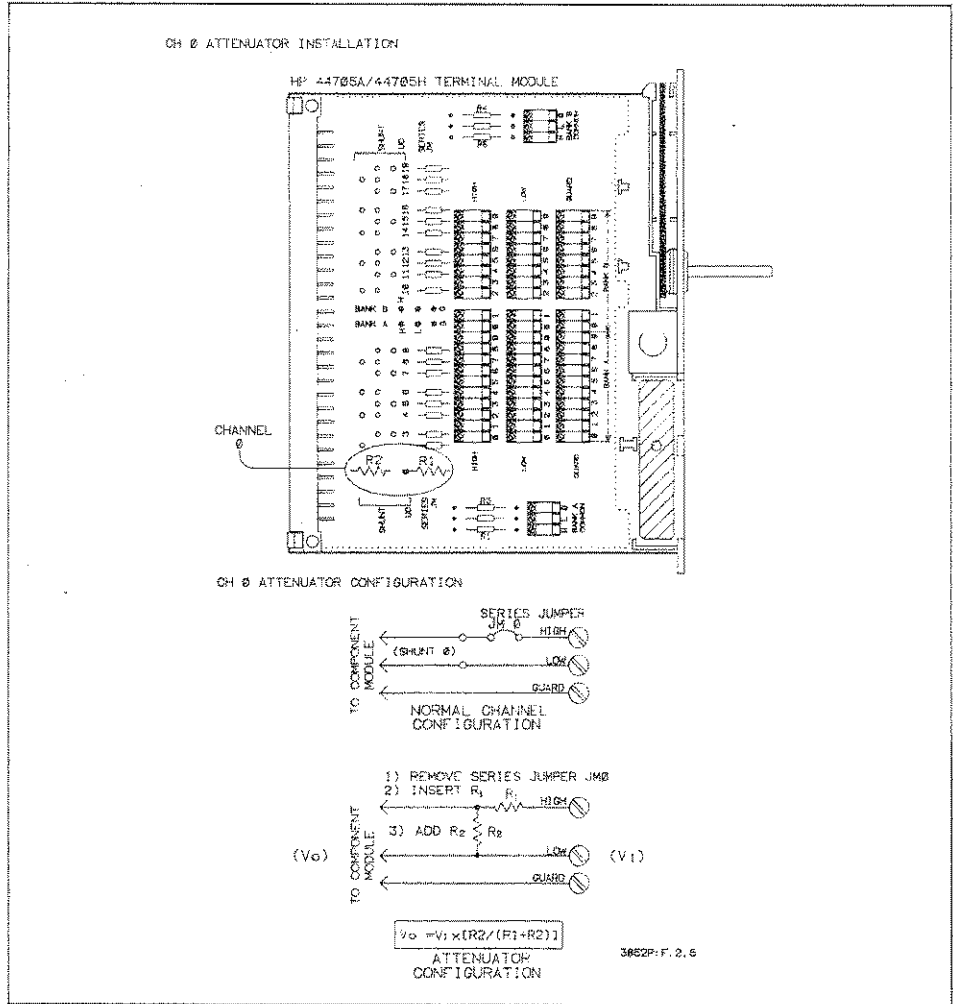

Figure 2-5. HP 44705A/44705H Attenuator Channel Configuration

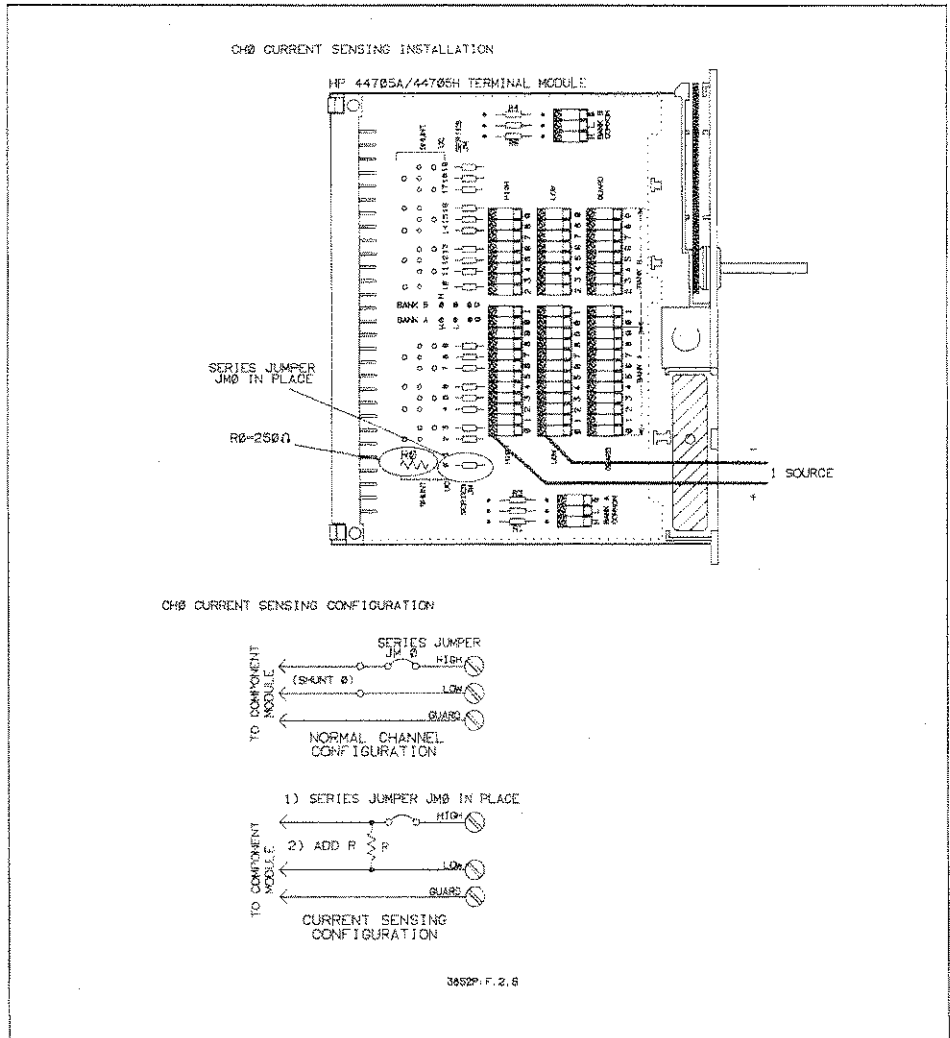

Figure 2-6. HP 44705A/44705H Current Sensing Configuration

NOTE

For measurements using the HP 44702A/B High-Speed Voltmeter shielded, twisted-pair cable is required for connections to the terminal module. Shielded, twisted-pair cable suitable for connections to the HP 44705A or HP 44705H multiplexer can be ordered from your nearest Hewlett-Packard Sales and Support Office. Order HP part number 03498-61602 which is a 2 metre shielded, twisted-pair cable with crimped and heat-shrunk wires attached to the braided shield at both ends.

Terminal Module Connections

Figure 2-7 shows the HP 44705A or HP 44705H terminal module with the cover removed. Each of the 20 channels has a HIGH, LOW, and GUARD terminal. Terminals 0 through 9 in Bank A are for channels 0 through 9, respectively. Terminals 0 through 9 in Bank B are for channels 10 through 19, respectively.

When connecting field wiring to the terminal module, route the wires under the strain relief clamp and tighten the clamp screw to reduce the chance of wires being pulled out of the terminal connectors. If the clamp screw is loosened far enough, the strain relief clamp can be rotated to make it easier to route the wiring.

When connecting components such as resistors, the lead length may be too short to route through the strain relief clamp. In this case, the components will have to be stored inside the terminal module. When connecting these components, make sure that no leads are shorted together and bend the leads to allow the terminal module cover to be replaced.

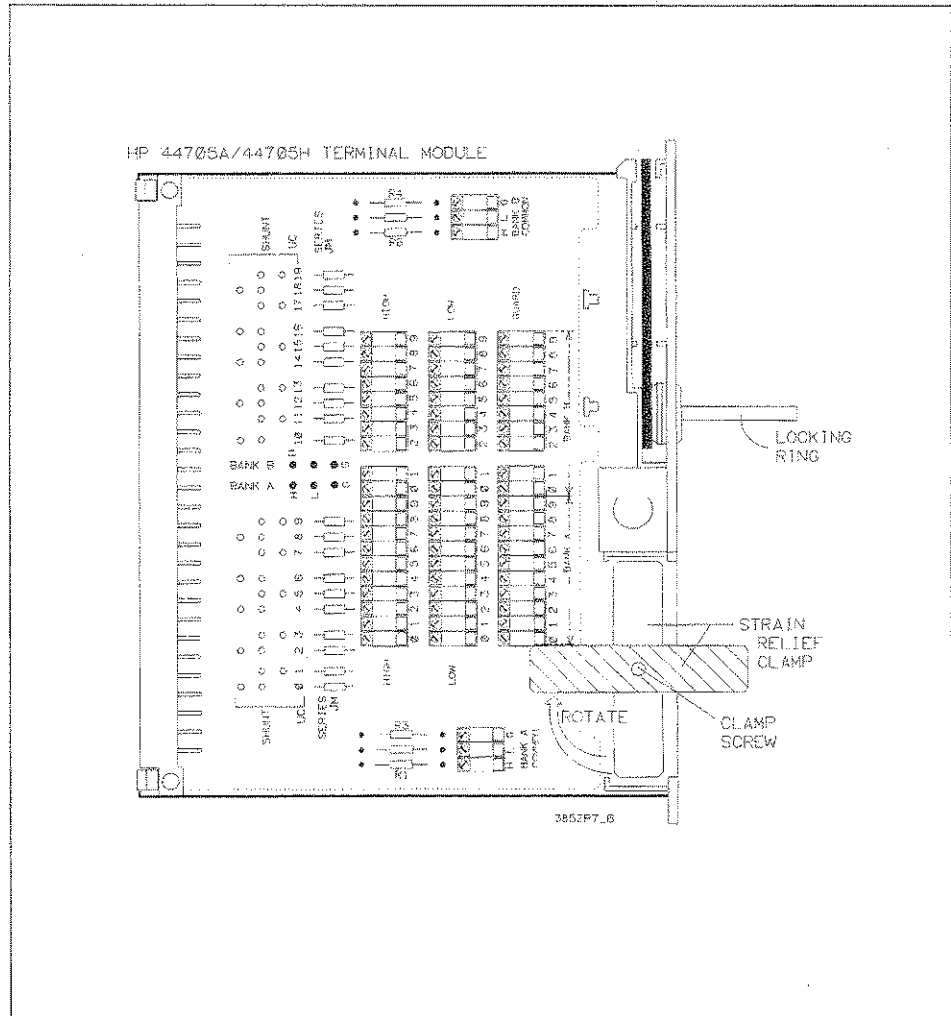

Figure 2-7. HP 44705A/44705H Terminal Module

Voltage Measurements Connections

The HP 44705A or HP 44705H can switch signals for up to 20 guarded (3-wire) DC or AC voltage measurements (DC voltage measurements only for inputs to the HP 44702A/B High-Speed Voltmeter). For guarded voltage measurements, HIGH, LOW, and GUARD lines are switched on each selected channel for maximum common mode noise rejection.

Figure 2-8 shows typical voltage measurement connections to channel 0 on the terminal module. Connect the HI (+) lead from the voltage source to channel 0 HIGH terminal and the LO (-) lead from the voltage source to the channel 0 LOW terminal. If a guarded (3-wire) voltage measurement is being made, connect the shield from the shielded twisted-pair cable to the channel 0 GUARD terminal.

Since shielded, twisted-pair cable reduces measurement noise, shielded cable is required for measurements with the HP 44702A/B voltmeter and is recommended for measurements with the HP 44701A voltmeter. Also, for the HP 44702A/B voltmeter, an external resistor (R) should be connected between the source voltage LO and the shield, as shown in Figure 2-8.

Resistance Measurements Connections

The HP 44705A or HP 44705H accessory can also be used to switch signals for resistance measurements using 2-wire and 4-wire ohms measurement techniques.

2-Wire Ohms Connections

In applications where the resistance of the test leads is not critical, the 2-wire ohms function can be used. Generally, the larger the resistance being measured, the less you have to be concerned about test lead resistances. Use the 2-wire ohms function to switch signals for up to 20 resistance measurements per HP 44705A or HP 44705H accessory.

Figure 2-9 shows typical 2-wire ohms measurement connections for a resistor (R0) connected to channel 0 on the terminal module with shielded, twisted-pair cable. Shielded cable and an external resistor R are required for inputs to the HP 44702A/B voltmeter. Shielded cable is highly recommended for inputs to the HP 44701A voltmeter. In Figure 2-9, note that one end of the shield lead is connected to the LO side of the resistor and the other end of the shield lead is connected to channel 0 GUARD.

For measurements with the HP 44702A/B High-Speed Voltmeter, use $R = 10\text{ k}\Omega$ to $100\text{ k}\Omega$. For measurements with the HP 44701A Integrating Voltmeter, make a direct connection from R0 LO to the shield (e.g., $R = 0$).

For measurements with the HP 44701A Integrating Voltmeter ONLY, if shielded cable is not used, connect one lead of the resistor to channel 0 HIGH terminal and the other lead of the resistor to channel 0 LOW terminal. If high common mode noise rejection is required, also connect a separate lead from resistor R0 LO to the channel 0 GUARD terminal.

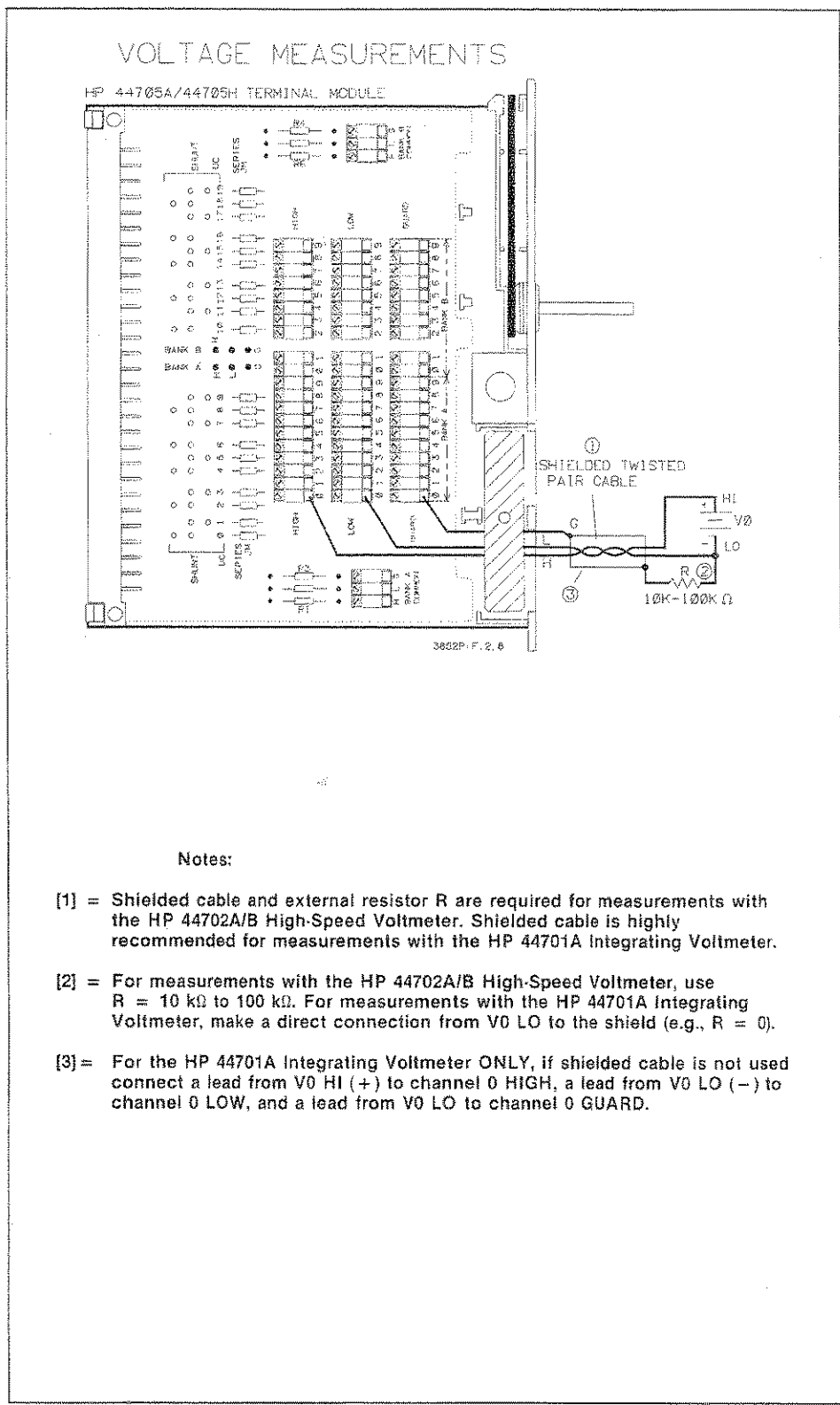
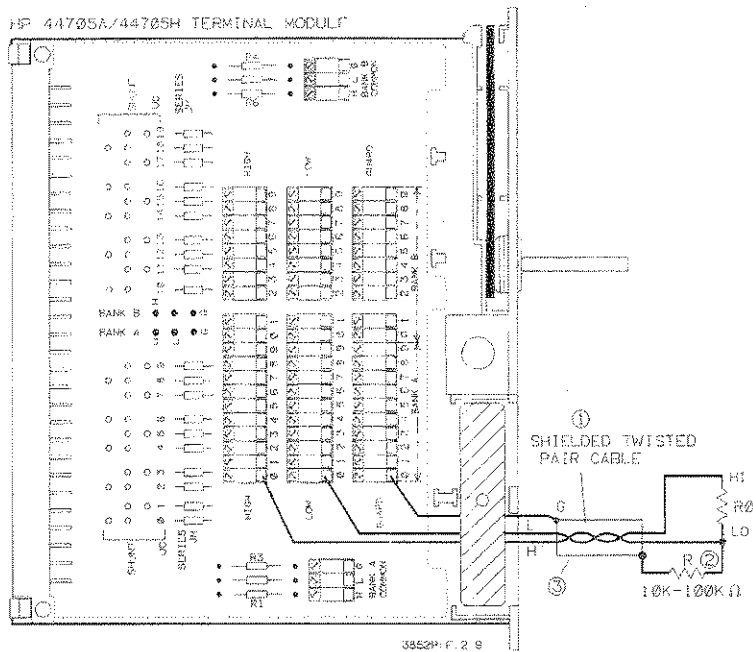

Figure 2-8. HP 44705A/44705H Voltage Connections

2-WIRE Ω MEASUREMENTS

HP 44705A/44705H TERMINAL MODULE



Notes:

- [1] = Shielded cable and external resistor R are required for measurements with the HP 44702A/B High-Speed Voltmeter. Shielded cable is highly recommended for measurements with the HP 44701A Integrating Voltmeter.
- [2] = For measurements with the HP 44702A/B High-Speed Voltmeter, use R = 10 k Ω to 100 k Ω . For measurements with the HP 44701A Integrating Voltmeter, make a direct connection from R0 LO to the shield (e.g., R = 0).
- [3] = For the HP 44701A Integrating Voltmeter ONLY, if shielded cable is not used connect a separate lead from the channel 0 GUARD terminal to R0 LO.

Figure 2-9. HP 44705A/44705H 2-Wire Ohms Connections

4-Wire Ohms Connections. Using 4-wire ohms measurements virtually eliminates the error caused by field wiring lead resistances. With 4-wire ohms, the current through the unknown resistance remains the same regardless of field wiring lead resistance and the voltmeter measures only the voltage across the unknown resistance.

The 4-wire ohms function is essential when highest accuracy is required. However, since each 4-wire ohms measurement requires two channels, a maximum of ten resistance measurements can be made per HP 44705A or HP 44705H accessory.

Each 4-wire ohms measurement requires two channels, one from Bank A and one from Bank B. When connecting a resistor to the terminal module for a 4-wire ohms measurement, use two channels that are separated by one decade (e.g., channels 0 and 10, channels 1 and 11, etc.).

See Figure 2-10 for 4-wire ohms connections of a resistance (R_0) connected to channel 0 and channel 10 using shielded, twisted-pair cable. (Shielded cable is required for inputs to the HP 44702A/B voltmeter and is highly recommended for inputs to the HP 44701A voltmeter.) Channel 0 is used as the voltage sense channel and channel 10 as the current source channel for the measurement.

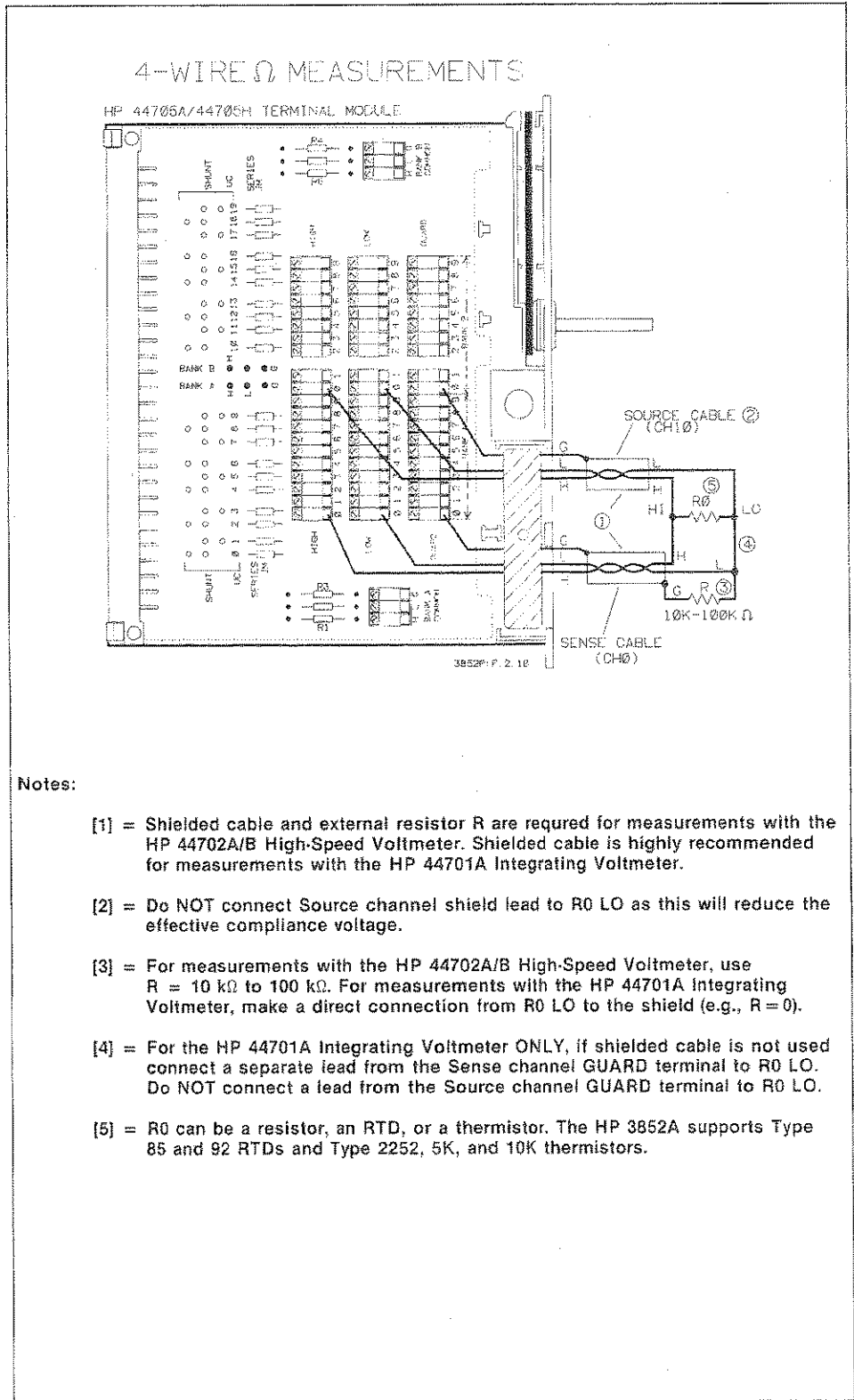

Figure 2-10. HP 44705A/44705H 4-Wire Ohms Connections

In Figure 2-10, note that one end of the Sense cable (channel 0) shield lead is connected to the channel 0 GUARD terminal and the other end of the shield lead is connected to R0 LO. However, although one end of the Source cable (channel 10) shield lead is connected to channel 10 GUARD, the other end of the shield lead is not connected to R0 LO. Do NOT connect the Source cable shield lead to R0 LO, as this will reduce the effective compliance voltage.

If you do not use shielded cable, connect channel 0 HIGH and LOW and channel 10 HIGH and LOW terminals to the resistor as shown in Figure 2-10 and connect a separate lead from the Sense channel (channel 0) GUARD terminal to the resistor LO. However, measurement accuracy with unshielded leads will not be as high as when shielded cable is used, since unshielded leads do not provide any noise immunity.

Temperature Measurements Connections

One of the functions of the HP 44705A or HP 44705H multiplexer is to switch signals for temperature measurements. This section shows how to connect RTDs and thermistors to the terminal module for temperature measurements.

RTD Connections

The resistance temperature detector (RTD) is a temperature-sensitive resistor that is typically stable, accurate, and linear. Since each 4-wire measurement requires two channels, up to ten RTD measurements can be made per HP 44705A or HP 44705H accessory. The HP 3852A resistance-to-temperature conversions support Type 85 and Type 92 RTDs (temperature coefficients (α) of 0.00385 $\Omega/\Omega/^\circ\text{C}$ and 0.003916 $\Omega/\Omega/^\circ\text{C}$, respectively, and resistance values of 100 Ω at 0 $^\circ\text{C}$).

Each 4-wire RTD measurement requires two channels, one from Bank A and one from Bank B. When connecting an RTD to the terminal module for a 4-wire measurement, use two channels that are separated by one decade (e.g., channels 0 and 10, channels 1 and 11, etc.). See Figure 2-10 in "4-Wire ohms Connections" for a typical connection diagram.

Thermistor Connections

Thermistors are capable of detecting small changes in temperature and are used in applications where the temperature extremes are not too high. Thermistors are highly dependent upon variables such as thermistor composition and size. Most thermistors have negative temperature coefficients which means that their resistance values decrease with increasing temperature.

Since each 4-wire measurement requires two channels, up to ten temperature measurements can be made per accessory. The HP 3852A resistance-to-temperature conversions support Type 2252, 5K, and 10K thermistors (resistance values at 25 $^\circ\text{C}$ of 2252 Ω , 5 k Ω , and 10 k Ω , respectively).

Each 4-wire thermistor measurement requires two channels, one from Bank A and one from Bank B. When connecting a thermistor to the terminal module for a 4-wire measurement, use two channels that are separated by one decade (e.g., channels 0 and 10, channels 1 and 11, etc.). See Figure 2-10 in "4-Wire ohms Connections" for a typical connection diagram.

Installation/Checkout

This section shows how to check the accessory identity, how to verify the field wiring connections, and how to read the state of the channels for an HP 44705A or HP 44705H multiplexer.

NOTE

The example programs in this manual use "709" as the HP-IB address for the HP 3852A. Specific slot and channel numbers are also used. Program syntax and data return formats apply to HP Series 200/300 Controllers. Modify slot and channel numbers as required.

Check Accessory ID

After you have connected field wiring from your application to the terminal module, replace the terminal module cover and install the accessory in the desired mainframe or extender slot. Refer to the HP 3852A Mainframe Configuration and Programming Manual to connect the terminal module to the component module and to install the accessory.

When the accessory is installed, use the ID? command to check the accessory ID. At power-on, an HP 44705A or HP 44705H returns 44705A. An HP 44705A or HP 44705H component module only (no terminal module attached) returns 447XXX. (Note that if the terminal module is removed after power-on, the accessory still returns 44705A.)

For example, the following program determines the identity of an accessory in slot 2 of the mainframe. An HP 44705A or HP 44705H multiplexer in this slot returns 44705A.

```
10 OUTPUT 709;"ID? 200"      !Query ID in mainframe slot 4
20 ENTER 709;A$              !Enter ID
30 PRINT A$                  !Display ID
40 END
```

If the multiplexer does not return 44705A or 44705H be sure you have addressed the correct slot and the terminal module is installed. If these are correct but the correct ID code is not returned, refer to the HP 3852A Assembly Level Service Manual for service procedures.

Verify Wiring Connections

To verify that your field wiring has been properly connected to the terminal module, send the MONMEAS (Monitor/Measure) command from the HP 3852A front panel keyboard or from a controller. This command can be used to check DC or AC voltage and 2-wire ohms connections. An example follows.

This program segment uses the MONMEAS command to verify DC voltage connections on channels 200 through 219 of an HP 44705A or HP 44705H multiplexer in slot 2 of the mainframe. The CONF command configures the voltmeter in slot 0 of the mainframe for DC voltage measurements.

The 20 channels are to be scanned and measured one at a time starting with channel 200. Press the SADV KEY key on the HP 3852A front panel to advance the scanning to the next channel. When the scan is advanced past the last channel (channel 219 in this example), scanning will stop and the last measurement will remain on the display.

```
10 OUTPUT 709;"USE 0"           !Use voltmeter in mainframe slot 0
20 OUTPUT 709;"CONF DCV"       !Set DC volts function on voltmeter
30 OUTPUT 709;"MONMEAS DCV,200-219" !Monitor/measure ch 200 through 219
40 END
```

Read Channel State

The CLOSE? command can be used to determine the state of HP 44705A or HP 44705H channels. This command returns one of five numbers as shown in Table 2-2 for each channel queried. The number returned indicates if a channel is open or closed and to which bus (Sense, Source, or both) the channel is connected.

Table 2-2. Values Returned by CLOSE?

Data Returned	Channel State
0	Channel Open
1	Channel Closed - not connected to Bus
2	Channel Closed - connected to Sense Bus
3	Channel Closed - connected to Source Bus
4	Channel Closed - connected to both Buses

Example: Reading Channel State

This program uses the CLOSE? command to check the state of channels 200 through 204 on an HP 44705A or HP 44705H in slot 2 of the mainframe. The RST (reset) command resets the multiplexer to its power-on state with all channels open. The CLOSE command closes channel 203 and the Bank A Sense Bus tree switch (channel 291). The OPEN command opens the channel and disconnects it from the backplane.

```

10 OUTPUT 709;"RST 200"           !Open all chs
20 INTEGER State(0:4)             !Define controller array
30 OUTPUT 709;"CLOSE 203,291"     !Close ch 203 and Sense Bus tree sw
40 OUTPUT 709;"CLOSE? 200-204"   !Query state of chs 200 through 204
50 ENTER 709;State(*)            !Enter state
60 PRINT State(*)                !Display state
70 OUTPUT 709;"OPEN 203,291"     !Open ch 203 and Sense Bus tree sw
80 END

```

For this example, since channel 203 was the only channel closed and was connected to the Sense Bus tree switch, a typical return is:

```
0 0 0 2 0
```

Chapter 3

Configuring The HP 44706A

Contents



1, 2

Configuration Overview	3-1
Warnings and Cautions	3-1
Block Diagram Description	3-2
Field Wiring Connections	3-5
Terminal Module Connections	3-5
Voltage Measurements Connections	3-6
Resistance Measurements Connections	3-9
Installation/Checkout	3-11
Check Accessory ID	3-11
Verify Wiring Connections	3-12
Read Channel State	3-12

Configuring the HP 44706A

Configuration Overview

This chapter shows how to configure the HP 44706A multiplexer accessory. It contains a block diagram description of the HP 44706A accessory, information on hardware configuring the terminal module, and information on connecting field wiring to the terminal module.

When you have configured the accessory for your application, refer to Chapter 5 - Programming the Multiplexers to program the accessory for voltage and 2-wire ohms resistance measurements.

Warnings and Cautions

This section contains WARNINGS and CAUTIONS applicable to the HP 44706A multiplexer. You should review the WARNINGS and CAUTIONS shown before configuring the multiplexer.

WARNING



SHOCK HAZARD. Only qualified, service-trained personnel who are aware of the hazards involved should install, remove, or configure any accessory. Before touching any installed accessory, turn off all power to the mainframe, extenders, and to all external devices connected to the mainframe, extenders, or accessories.

WARNING



POSSIBLE OPERATOR INJURY. For safety, consider all accessory channels to be at the highest potential applied to any channel. Under most conditions of failure, the relays on the relay multiplexers will remain in whatever state the program sets them.

However, for some equipment failures, the relays may not remain in their programmed state. If the relays settle in the closed state, the relay contacts may weld together and the highest voltage present on any one channel may be present on all channels. This condition may cause operator injury if the terminals are touched or equipment damage may result.



WARNING

MAXIMUM VOLTAGE LIMITATIONS. The HP 3852A and the HP 3853A internal analog buses interconnect the multiplexer and voltmeter accessories to form one circuit. To protect against possible personal injury due to equipment failure or programming error, limitations are placed on the potentials that can appear between any two points on the circuit (or between the circuit and chassis).

These limitations are listed for the HP 3852A, HP 3853A, and all plug-in accessories. For any given set of accessories installed in the mainframe or extender, the maximum potential between any two points is determined by the accessory with the LOWEST peak voltage limitation, as shown. (If the analog extender cable is NOT connected between the mainframe and the extenders, each instrument is considered as a separate circuit.)

The maximum nondestructive voltage which can be applied to the HP 44706A is 42 VDC or 30 VAC rms (42 V peak).

<i>Instrument/Accessory</i>	<i>Peak Voltage</i>
<i>HP 3852A Mainframe</i>	<i>350 V</i>
<i>HP 3853A Extender</i>	<i>350 V</i>
<i>HP 44701A Integrating Voltmeter</i>	<i>350 V</i>
<i>HP 44702A/B High-Speed Voltmeter</i>	<i>42 V</i>
<i>HP 44705A/08A/17A/18A 20-Channel Relay Multiplexers</i>	<i>170 V</i>
<i>HP 44705H/08H 20-Channel High-Voltage Relay Multiplexers</i>	<i>354 V</i>
<i>HP 44706A 60-Channel Relay Multiplexer</i>	<i>42 V</i>
<i>HP 44709A/10A/11A/12A/13A FET Multiplexers</i>	<i>42 V</i>

CAUTION

STATIC SENSITIVE. Use clean-handling techniques when handling the accessory. Do not install an accessory without the metal covers attached.

Block Diagram Description

The HP 44706A accessory consists of a 60-channel terminal module and a component module as shown in Figure 3-1. Field wiring from your application sensors (such as voltage sources) is connected to the terminal module and the signals are sent to the switches located on the component module.

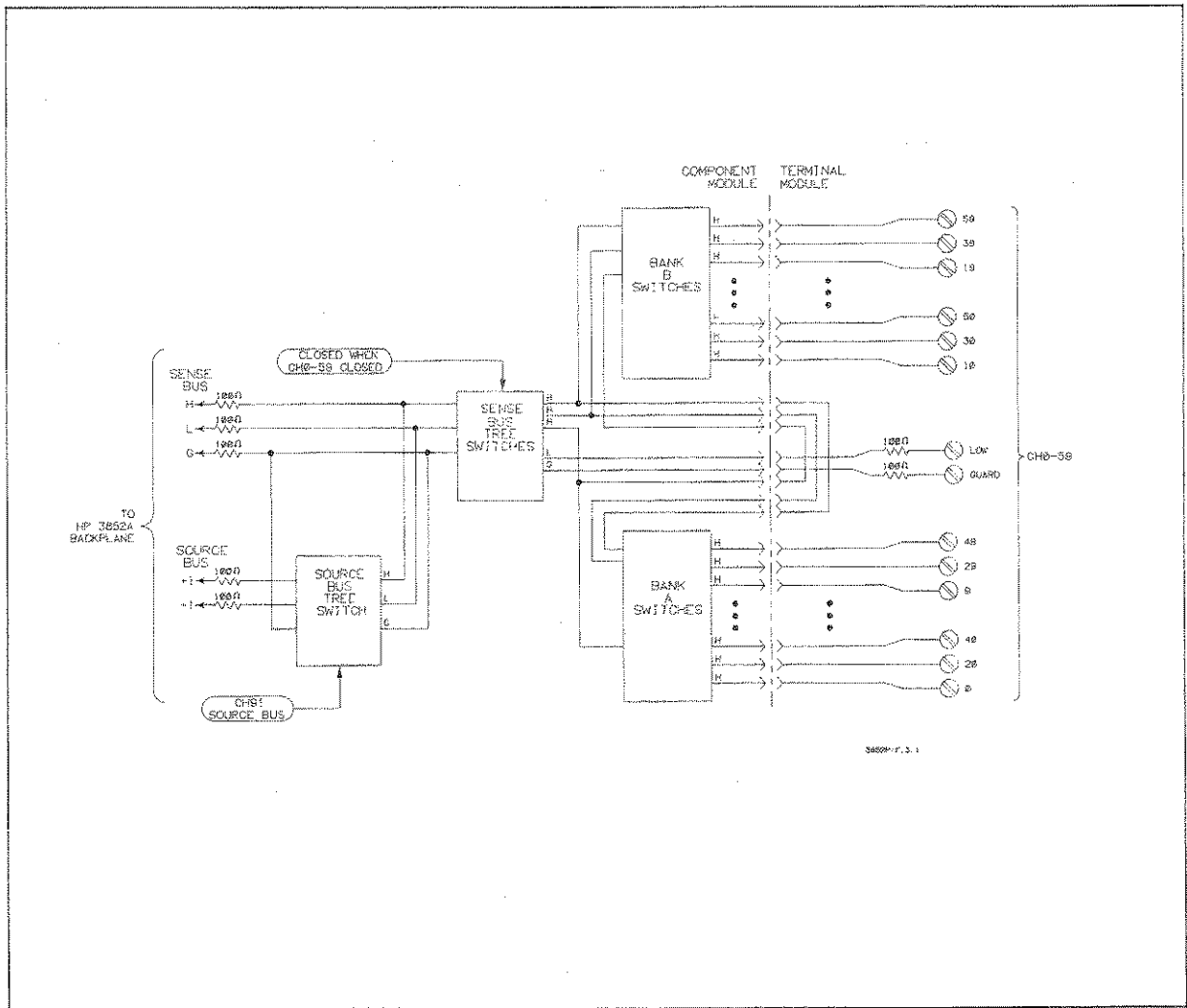

Figure 3-1. HP 44706A Block Diagram

Component Module

The component module consists of two types of switches: bank switches and tree switches. There are 60 bank switches divided into two groups of 30 channels each: Bank A and Bank B. Unlike the guarded multiplexer accessories, the HP 44706A switches the HIGH line only. LOW and GUARD are common to all channels, but are not switched.

NOTE

Only one bank switch can be closed at a time. Closing a second bank switch will open any previously closed bank switch.

The component module contains two types of tree switches: Source Bus and Sense Bus. There are three Sense Bus tree switches and one Source Bus tree switch. The tree switches control signal flow to and from the HP 3852A backplane and also isolate the bank switches from the backplane when they are not in use.

The Sense Bus tree switches provide connections to the backplane to make voltage measurements. The Source Bus tree switches provide backplane connections to the HP 44701A or HP 44702A/B voltmeter current sources (+I and -I) to make resistance measurements.

Terminal Module

The terminal module contains 60 terminals to connect field wiring. As factory configured, there is a 100 Ω resistor in series with the LOW terminal and with the GUARD terminal on the terminal module. Five 100 Ω resistors on the component module connect the tree switches to the HP 3852A backplane.

Channel Definitions

Table 3-1 shows the channel definitions for the HP 44706A accessory. Channels 0 through 59 control the bank switches. When a command is executed to close a channel, the appropriate Sense Bus tree switches are also automatically closed. Channel 91 controls the Source Bus tree switch for all 60 channels.

If you use high-level commands (such as CONFMEAS and MEAS) to program the accessory, you need to specify only the measurement channels since CONFMEAS or MEAS automatically closes the proper channels and switches for the measurement selected.

However, if you use low-level commands such as CLOSE and OPEN for measurements, you will need to specify the switches which are to be closed. For example, to make voltage measurements on channel 0, you will need to close the measurement channel (channel 0) which also closes the Sense Bus tree switch.

To make resistance measurements (2-wire ohms), you will need to close both the Sense Bus and Source Bus tree switches and the measurement channel. For example, to make 2-wire ohms resistance measurements on channel 0, close the measurement channel (channel 0) (which also closes the Sense Bus tree switch) and the Source Bus tree switch (channel 91).

Table 3-1. HP 44706A Channel Definitions

Channel	Definitions
0 - 59 91	Bank Switches/Sense Bus Tree Switch Source Bus Tree Switch

Field Wiring Connections

This section contains example field wiring connections to the HP 44706A terminal module for voltage and (2-wire ohms) resistance measurements.

NOTE

For measurements using the HP 44702A/B High-Speed Voltmeter shielded, twisted-pair cable is required for connection to the terminal module. Shielded, twisted-pair cable suitable for connections to the HP 44705A or HP 44705H multiplexer can be ordered from your nearest Hewlett-Packard Sales and Support Office. Order HP part number 03498-61602 which is a 2 metre shielded, twisted-pair cable with crimped and heat-shrunk wires attached to the braided shield at both ends.

Terminal Module Connections

Figure 3-2 shows the HP 44706A terminal module with the cover removed. Each of the 60 channels has a HIGH terminal (numbered 0 through 59), a common LOW terminal, and a common GUARD terminal.

When connecting field wiring to the terminal module, route the wires under the strain relief clamp and tighten the clamp screw to reduce the chance of wires being pulled out of the terminal connectors. If the clamp screw is loosened far enough, the strain relief clamp can be rotated to make it easier to route the wiring.

When connecting components such as resistors, the lead length may be too short to route through the strain relief clamp. In this case, the components will have to be stored inside the terminal module. When connecting these components, make sure that no leads are shorted together and bend the leads to allow the terminal module cover to be replaced.

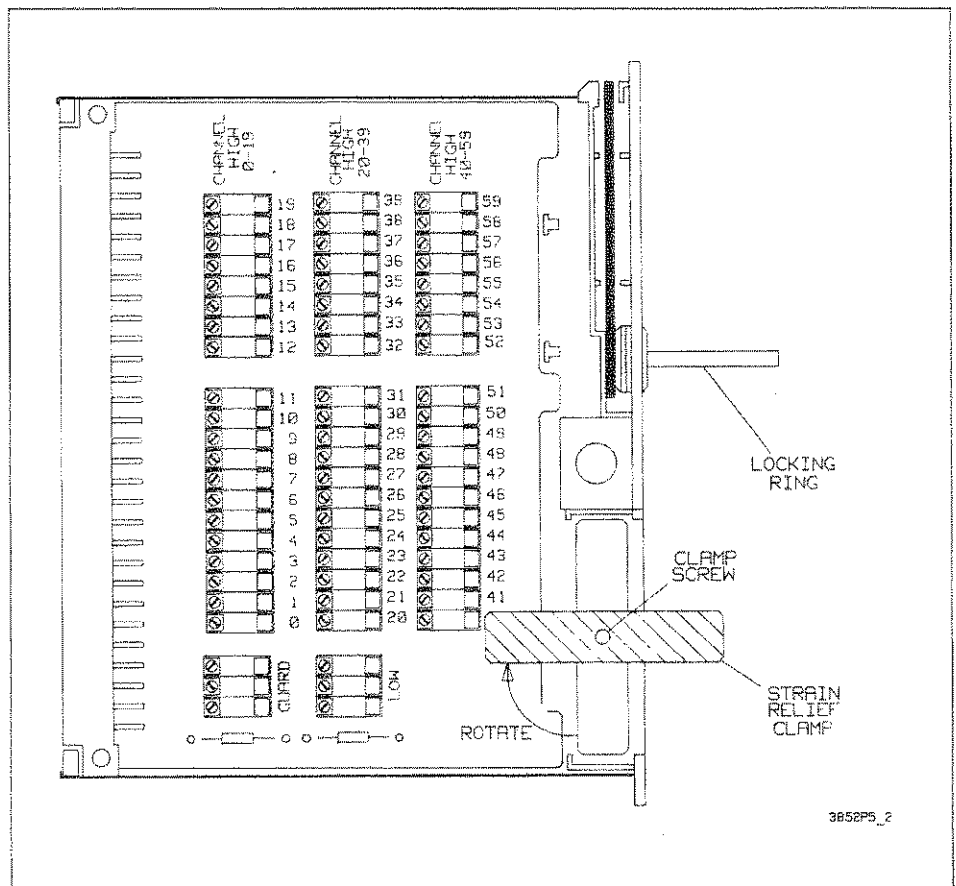

Figure 3-2. HP 44706A Terminal Module

Voltage Measurements Connections

The HP 44706A multiplexer can switch signals for up to 60 single-ended DC or AC voltage measurements (DC voltage measurements only for inputs to the HP 44702A/B High-Speed Voltmeter). When making single-ended voltage measurements, only the HIGH line is switched. LOW and GUARD are common to each channel but are not switched.

Figure 3-3 shows typical voltage measurement connections to channel 0 on the terminal module. Connect the HI (+) lead from the voltage source to channel 0 HIGH terminal and the LO (-) lead from the voltage source to the common LOW terminal. If a guarded (3-wire) voltage measurement is being made, connect the shield from the shielded, twisted-pair cable to the common GUARD terminal.

Since shielded, twisted-pair cable reduces measurement noise, shielded cable is required for measurements with the HP 44702A/B voltmeter and is highly recommended for measurements with the HP 44701A voltmeter. Also, for the HP 44702A/B voltmeter, an external resistor (R) should be connected between the source voltage LO and the shield, as shown in Figure 3-3.

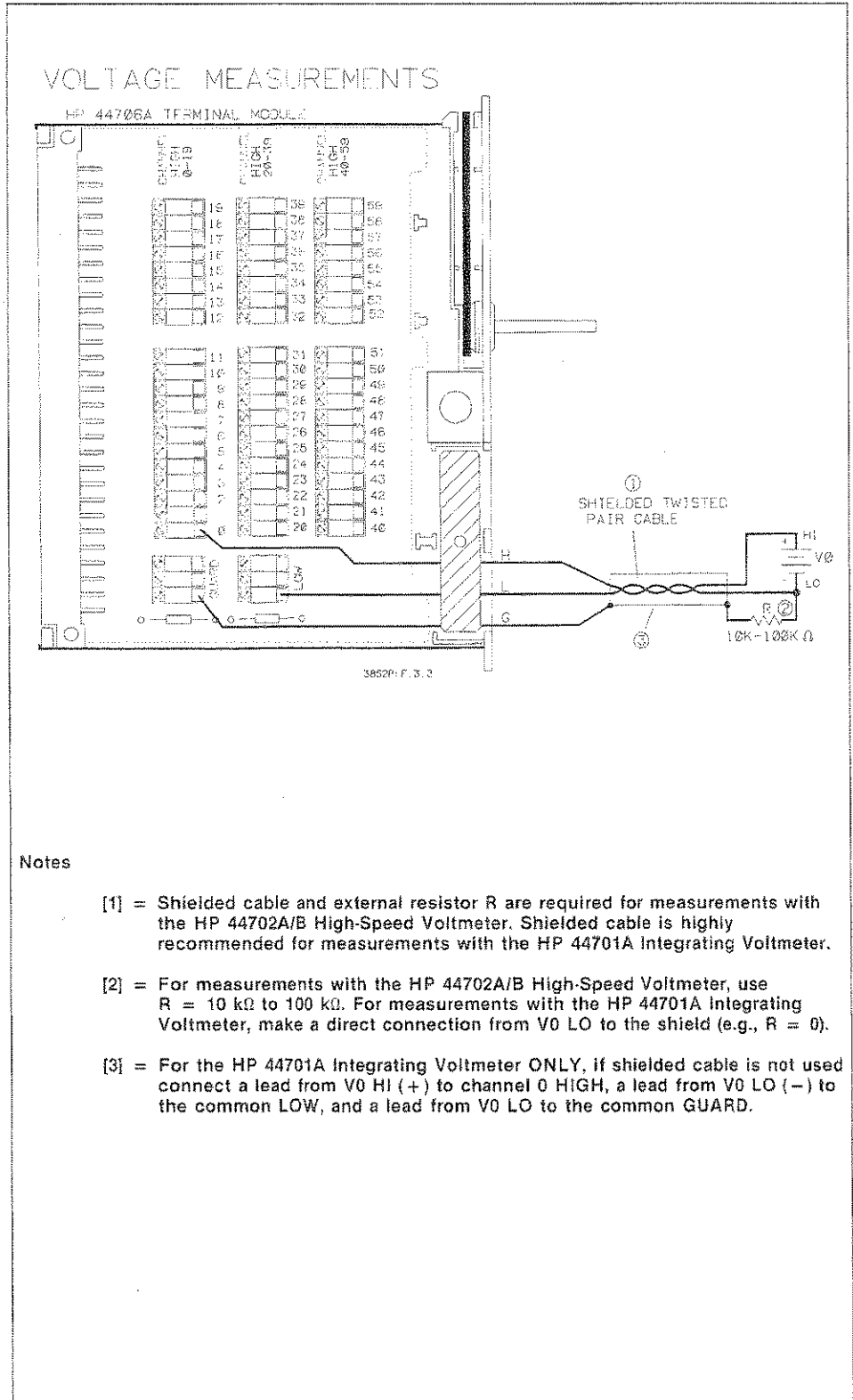

Figure 3-3. HP 44706A Voltage Connections

Resistance Measurements Connections

The HP 44706A accessory can also be used to switch signals for resistance measurements using 2-wire ohms measurement techniques. In applications where the resistance of the test leads is not critical, the 2-wire ohms function can be used. Generally, the larger the resistance being measured, the less you have to be concerned about test lead resistances.

Use the 2-wire ohms function to switch signals for up to 60 resistance measurements per HP 44706A accessory. Figure 3-4 shows typical 2-wire ohms measurement connections for a resistor (R0) connected to channel 0 on the terminal module with shielded, twisted-pair cable.

Shielded cable is required for inputs to the HP 44702A/B voltmeter and is highly recommended for inputs to the HP 44701A voltmeter. In Figure 3-4, note that one end of the shield lead is connected to the LO side of the resistor and the other end of the shield lead is connected to the common GUARD terminal.

For measurements with the HP 44702A/B High-Speed Voltmeter, use $R = 10 \text{ k}\Omega$ to $100 \text{ k}\Omega$. For measurements with the HP 44701A Integrating Voltmeter, make a direct connection from R0 LO to the shield (e.g., $R = 0$).

For measurements with the HP 44701A Integrating Voltmeter ONLY, if shielded cable is not used connect one lead of the resistor to channel 0 HIGH terminal and the other lead of the resistor to common LOW terminal. If high common mode noise rejection is required, also connect a separate lead from resistor R0 LO to the common GUARD terminal.

NOTE

Due to the 100Ω protection resistor in series with the LOW terminal on the terminal module, there is a 100Ω offset error when making 2-wire ohms measurements with the HP 44706A. This resistor can be shorted out, but this will seriously shorten relay life if high voltages or currents are switched.

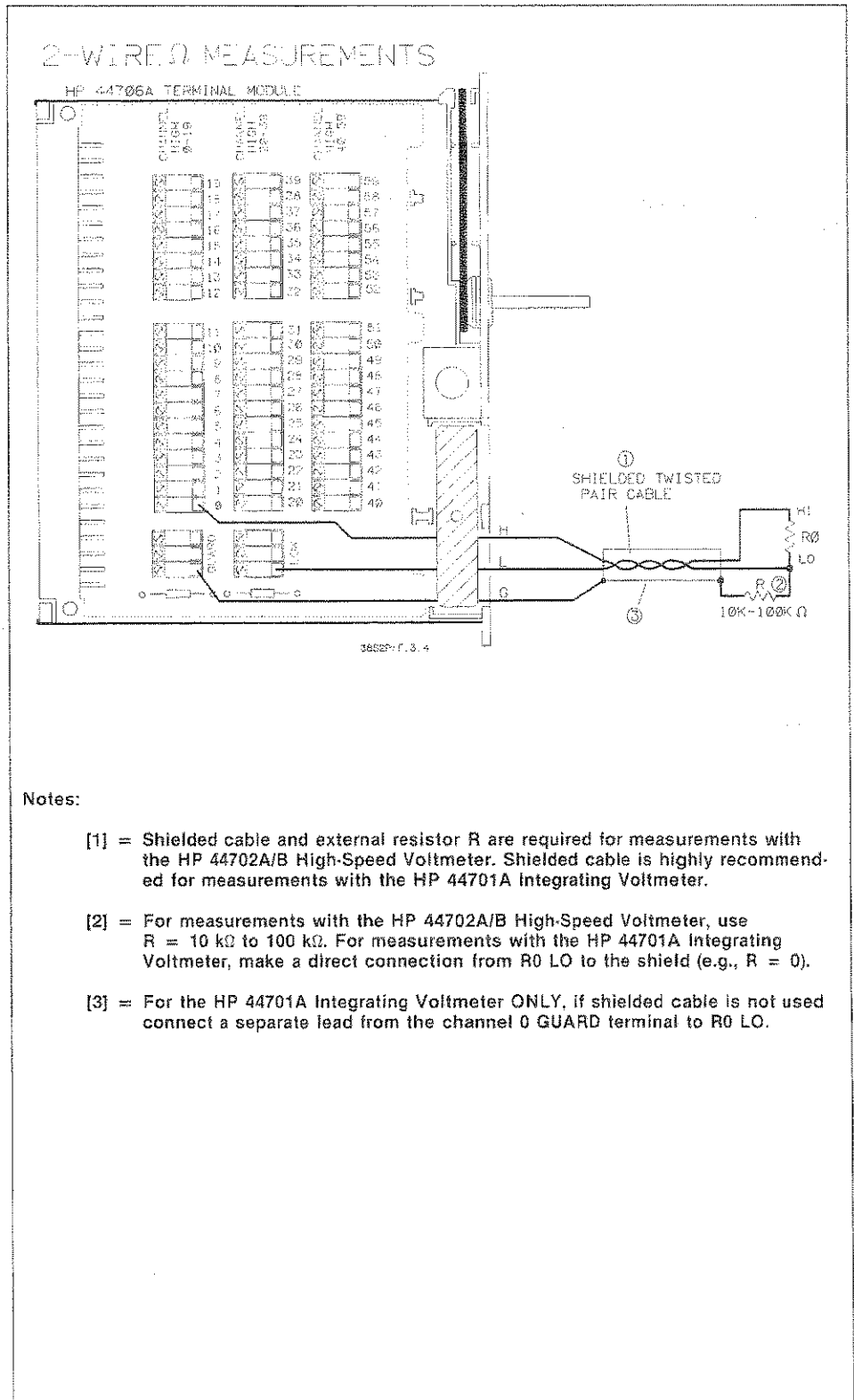

Figure 3-4. HP 44706A 2-Wire Ohms Connections

Installation/Checkout

This section shows how to check the accessory identity, how to verify the field wiring connections, and how to read the state of the channels for an HP 44706A multiplexer.

NOTE

The example programs in this manual use "709" as the HP-IB address for the HP 3852A. Specific slot and channel numbers are also used. Program syntax and data return formats apply to HP Series 200/300 Controllers. Modify slot and channel numbers as required.

Check Accessory ID

After you have connected field wiring from your application to the terminal module, replace the terminal module cover and install the accessory in the desired mainframe or extender slot. Refer to the HP 3852A Mainframe Configuration and Programming Manual to connect the terminal module to the component module and to install the accessory.

When the accessory is installed, use the ID? command to check the accessory ID. At power-on, an HP 44706A returns 44706A. An HP 44706A component module only (no terminal module attached) returns 447XXX. (Note that if the terminal module is removed after power-on, the accessory still returns 44706A.)

For example, the following program determines the identity of an accessory in slot 2 of the mainframe. An HP 44706A multiplexer in this slot returns 44706A.

```
10 OUTPUT 709;"ID? 200"      !Query ID in mainframe slot 4
20 ENTER 709;A$             !Enter ID
30 PRINT A$                  !Display ID
40 END
```

If the multiplexer does not return 44706A, be sure you have addressed the correct slot and the terminal module is installed. If these are correct but the correct ID code is not returned, refer to the HP 3852A Assembly Level Service Manual for service procedures.

Verify Wiring Connections

To verify that your field wiring has been properly connected to the terminal module, send the MONMEAS (Monitor/Measure) command from the HP 3852A front panel keyboard or from a controller. This command can be used to check DC or AC voltage and 2-wire ohms connections. An example follows.

This program segment uses the MONMEAS command to verify DC voltage connections on channels 200 through 204 of an HP 44706A multiplexer in slot 2 of the mainframe. The CONF command configures the voltmeter in slot 0 of the mainframe for DC voltage measurements.

The 5 channels are to be scanned and measured one at a time starting with channel 200. Press the SADV KEY key on the HP 3852A front panel to advance the scanning to the next channel. When the scan is advanced past the last channel (channel 204 in this example), scanning will stop and the last measurement will remain on the display.

```
10 OUTPUT 709;"USE 0"           !Use voltmeter in mainframe slot 0
20 OUTPUT 709;"CONF DCV"       !Set DC volts function on voltmeter
30 OUTPUT 709;"MONMEAS DCV,200-204" !Monitor/measure ch 200 through 204
40 END
```

Read Channel State

The CLOSE? command can be used to determine the state of the HP 44706A channels. This command returns one of five numbers as shown in Table 3-2 for each channel queried. The number returned indicates if a channel is open or closed and to which bus (Sense, Source, or both) the channel is connected.

Table 3-2. Values Returned by CLOSE?

Data Returned	Channel State
0	Channel Open
1	Channel Closed (Valid only for Source Bus tree switch - channel 91)
2	Channel Closed - connected to Sense Bus
4	Channel Closed - connected to Sense Bus and Source Bus

Example: Reading Channel State

This program uses the CLOSE? command to check the state of channels 200 through 204 of an HP 44706A in slot 2 of the mainframe. The RST (reset) command resets the multiplexer to its power-on state with all channels open. The CLOSE command closes channel 203 and the Sense Bus tree switch. The OPEN command opens the channel and disconnects it from the backplane.

```

10 OUTPUT 709;"RST 200"           !Open all channels
20 INTEGER State (0:4)           !Define controller array
30 OUTPUT 709;"CLOSE 203"        !Close ch 203 and Sense Bus tree sw
40 OUTPUT 709;"CLOSE? 200-204"   !Query state of chs 200 through 204
50 ENTER 709;State(*)           !Enter state
60 PRINT State(*)               !Display state
70 OUTPUT 709;"OPEN 203"        !Open ch 203 and Sense Bus tree sw
80 END

```

For this example, since channel 203 was the only channel closed, a typical return is:

```
0 0 0 2 0
```

Chapter 4

Configuring The HP 44708A/44708H

Contents



1, 2

Configuration Overview.....	4-1
Warnings and Cautions.....	4-1
Block Diagram Description.....	4-4
Terminal Module Configuration.....	4-7
Isolation Jumper.....	4-7
Low-Pass Filters.....	4-8
Attenuators.....	4-10
Current Sensing.....	4-11
Field Wiring Connections.....	4-13
Terminal Module Connections.....	4-13
Voltage Measurements Connections.....	4-14
Resistance Measurements Connections.....	4-15
Thermocouple Measurements Connections.....	4-18
Installation/Checkout.....	4-20
Check Accessory ID.....	4-20
Verify Wiring Connections.....	4-21
Read Channel State.....	4-21

Configuring the HP 44708A/44708H

Configuration Overview

This chapter shows how to configure the HP 44708A and HP 44708H multiplexer accessories. It contains a block diagram description of the accessories, information on hardware configuring the terminal modules, and information on connecting field wiring to the terminal modules.

When you have configured the accessory for your application, refer to Chapter 5 - Programming the Multiplexers to program the accessories for voltage, current, 2-wire ohms, and thermocouple measurements.

Warnings and Cautions

This section contains WARNINGS and CAUTIONS applicable to the HP 44708A and HP 44708H multiplexers. You should review the WARNINGS and CAUTIONS shown before configuring the accessories.



1

WARNING

SHOCK HAZARD. Only qualified, service-trained personnel who are aware of the hazards involved should install, remove, or configure any accessory. Before touching any installed accessory, turn off all power to the mainframe, extenders, and to all external devices connected to the mainframe, extenders, or accessories.



2

WARNING

POSSIBLE OPERATOR INJURY. For safety, consider all accessory channels to be at the highest potential applied to any channel. Under most conditions of failure, the relays on the relay multiplexers will remain in whatever state the program sets them.

However, for some equipment failure, the relays may not remain in their programmed state. If the relays settle in the closed state, the relay contacts may weld together and the highest voltage present on any one channel may be present on all channels. This condition may cause operator injury if the terminals are touched or equipment damage may result.

WARNING



MAXIMUM VOLTAGE LIMITATIONS. The HP 3852A and the HP 3853A internal analog buses interconnect the multiplexer and voltmeter accessories to form one circuit. To protect against possible personal injury due to equipment failure or programming error, limitations are placed on the potentials that can appear between any two points on the circuit (or between the circuit and chassis).

The limitations are listed for the HP 3852A, HP 3853A, and all plug-in accessories. For any given set of accessories installed in the mainframe or extender, the maximum potential between any two points is determined by the accessory with the LOWEST peak voltage limitation, as follows. (If the analog extender cable is NOT connected between the mainframe and the extenders, each instrument is considered as a separate circuit.)

The maximum nondestructive voltage which can be applied to the HP 44708A is 170 VDC or 120 VAC rms (170 V peak). The maximum nondestructive voltage which can be applied to the HP 44708H is 250 VDC or 250 VAC rms (354 V peak).

<i>Instrument/Accessory</i>	<i>Peak Voltage</i>
<i>HP 3852A Mainframe</i>	<i>350 V</i>
<i>HP 3853A Extender</i>	<i>350 V</i>
<i>HP 44701A Integrating Voltmeter</i>	<i>350 V</i>
<i>HP 44702A/B High-Speed Voltmeter</i>	<i>42 V</i>
<i>HP 44705A/08A/17A/18A 20-Channel Relay Multiplexers</i>	<i>170 V</i>
<i>HP 44705H/08H 20-Channel High-Voltage Relay Multiplexers</i>	<i>354 V</i>
<i>HP 44706A 60-Channel Relay Multiplexer</i>	<i>42 V</i>
<i>HP 44709A/10A/11A/12A/13A FET Multiplexers</i>	<i>42 V</i>

CAUTION

POSSIBLE EQUIPMENT DAMAGE. When making high-voltage measurements with HP 44705A or HP 44705H, the HP 3852A analog backplane becomes charged to the voltage on the last channel connected to it. Thus, the next channel that is closed may have to absorb all of the stored energy on the backplane.

If the backplane is not discharged after making a high-voltage measurement, the voltage present on the backplane must be added to the voltage being switched on the next channel to determine the total relay contact voltage. See Figure 4-1 for guidelines to maximize relay life and prevent damage to sensitive transducers by high backplane discharge voltages.

- When measuring high-voltages, connect the line which has the highest maximum absolute peak voltage of the source to the HIGH terminal on the terminal module. Connect the line which has the lowest absolute peak voltage of the source to the LOW terminal on the terminal module. Connect the guard line ONLY if high common mode noise rejection is necessary, otherwise, do not connect the guard line.

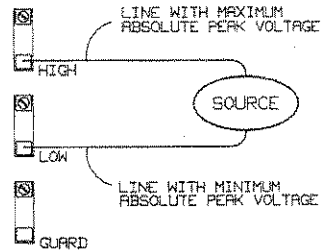

OR

- Discharge the HP 3852A analog backplane to earth ground through 10 kΩ resistors connected to HIGH, LOW, and GUARD on an unused channel.

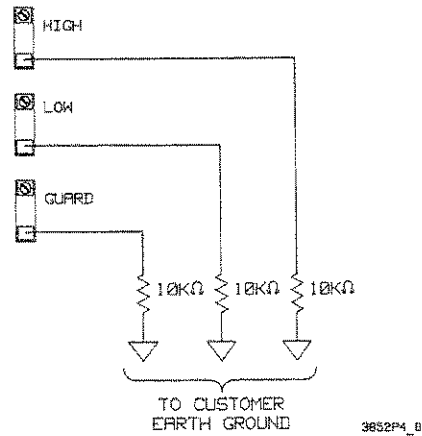

Figure 4-1. Discharging the HP 3852A Backplane

CAUTION

STATIC SENSITIVE. Use clean-handling techniques when handling the accessory. Do not install an accessory without the metal covers attached.

Block Diagram Description

The HP 44708A and HP 44708H accessories consist of a 20-channel terminal module and a component module as shown in Figure 4-2. Field wiring from application sensors (such as thermocouples) is connected to the terminal module and the input signal is sent to the Bank A switches or Bank B switches located on the component module.

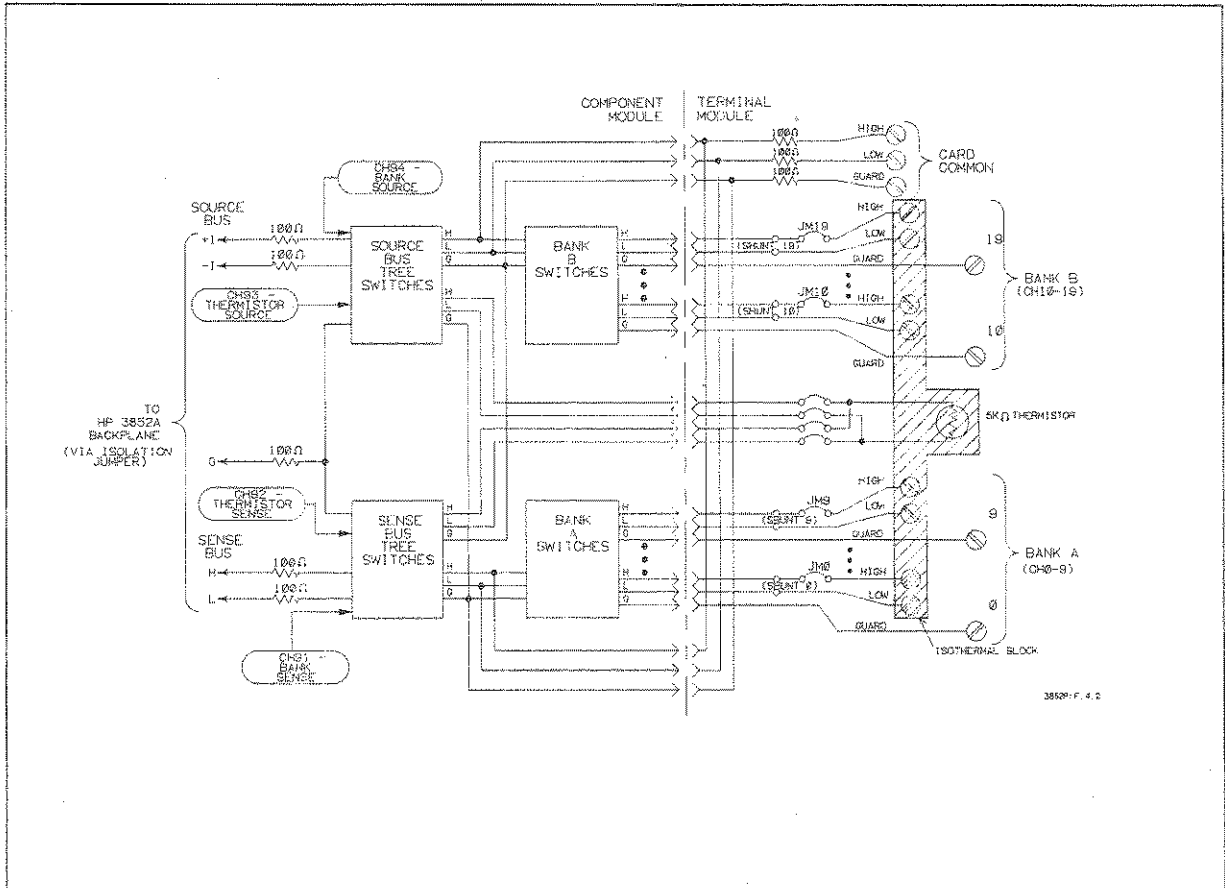

Figure 4-2. HP 44708A/44708H Block Diagram

A special isothermal connector block on the terminal module provides the reference junction for thermocouple measurements. A thermistor mounted on the isothermal connector block is used to measure the isothermal block reference temperature. The HP 3852A uses software compensation to automatically compensate for the reference temperature when making thermocouple measurements.

Component Module

The component module consists of 24 switches which are divided into two categories: bank switches and tree switches. Each of the 24 switches consists of three reed-actuated relays, one each for HIGH, LOW, and GUARD lines. There are 20 bank switches divided into two groups of 10 channels each: Bank A and Bank B. The channels in Bank A are numbered 0 through 9 and the channels in Bank B are numbered 10 through 19.

NOTE

Only one channel per bank can be closed at a time. Closing a second channel in a bank will open any previously closed channel in that bank.

The component module contains four tree switches which are of two types: Source Bus tree switches and Sense Bus tree switches. The 20 bank switches share a Source Bus tree switch and a Sense Bus tree switch. The other Source Bus and Sense Bus tree switches are used to measure the reference temperature when making thermocouple measurements.

The tree switches control signal flow to and from the HP 3852A backplane and also isolate the bank switches from the backplane when they are not in use. The Sense Bus tree switches provide connections to the backplane for making voltage measurements. The Source Bus tree switches provide backplane connections to the HP 44701A or HP 44702A/B voltmeter current source connections (+ I and - I) for making resistance measurements.

NOTE

Two tree switches of the same type cannot be closed simultaneously (e.g., only one of the two Sense Bus tree switches can be closed at a time). Closing a second tree switch will open any previously closed tree switch of the same type.

Five resistors on the component module connect the tree switches to the HP 3852A backplane which provide current limiting protection for the relays on the component module. The resistors do not affect resistance measurements (2-wire ohms error due to contact and trace error is $< 2 \Omega$). The resistors can be shorted out, but this will seriously shorten relay life if high voltages or currents are switched.

The component module also includes an Isolation Jumper which allows you to disconnect the tree switches from the HP 3852A backplane for special signal routing applications. Refer to "Isolation Jumper" for information on setting the Isolation Jumper.

Terminal Module

The terminal module contains 20 channels of terminal connectors for field wiring, a CARD COMMON terminal, and an isothermal block with a 5 k Ω thermistor. Note that the HIGH and LOW terminals for each channel are mounted on the isothermal block, but the GUARD terminals are not. The 5 k Ω thermistor is used to measure the isothermal block temperature to arrive at the reference temperature.

The bank switch terminals are connected together on the terminal module to form the CARD COMMON terminal. As factory configured, there is a current limiting resistor in series with the CARD COMMON HIGH, LOW, and GUARD terminals.

Channel Definitions

Table 4-1 shows the channel definitions for the HP 44708A and HP 44708H accessories. Channels 0 through 19 control the bank switches, channels 91 and 94 control the tree switches for the measurement channels, and channels 92 and 93 control the tree switches for thermistor measurements on the isothermal block. Because of this configuration, the HP 44708A or HP 44708H cannot be used for 4-wire ohms measurements.

If you use high-level commands (such as CONFMEAS or MEAS) to close channels, the high-level command automatically closes the proper channels and switches for the measurement selected. However, if you use low-level commands such as CLOSE and OPEN for measurements, you will need to specify the switches which are to be closed.

For example, to make voltage measurements on channel 0, you will need to close the Sense Bus tree switch (channel 91) and the measurement channel (channel 0). Or, to make voltage measurements on channel 19, close the Sense Bus tree switch (channel 91) and the measurement channel (channel 19).

To make 2-wire ohms resistance measurements, you will need to close both the Sense Bus and Source Bus tree switches and the measurement channel. For example, to make resistance measurements on channel 0, close the Sense Bus tree switch (channel 91), the Source Bus tree switch (channel 94), and the measurement channel (channel 0).

To measure the reference temperature (by measuring the thermistor on the isothermal block), close the Sense Bus tree switch (channel 92) and the Source Bus tree switch (channel 93).

Table 4-1. HP 44708A/44708H Channel Definitions

Channel	Definitions
0 - 9	Bank A Switches
10 - 19	Bank B Switches
91	Sense Bus Tree Switch (Bank sense)
92	Sense Bus Tree Switch (thermistor sense)
93	Source Bus Tree Switch (thermistor source)
94	Source Bus Tree (Bank source)

Terminal Module Configuration

This section shows how to hardware configure the HP 44708A and HP 44708H terminal modules. It shows how to set the Isolation Jumper, how to configure the terminal modules for low-pass filtering and signal attenuation, and how to install resistors on the terminal module to configure the multiplexers for current sensing applications.

Isolation Jumper The tree switches on the HP 44708A or HP 44708H multiplexers can be connected or disconnected from the HP 3852A backplane using the Isolation Jumper. Figure 4-3 shows the location of the Isolation Jumper (J1) on the component module.

The jumper has an EN (enable) and DIS (disable) position. For normal operation, the jumper should be in the EN position to connect the tree switches to the backplane. For special applications which require tree switch isolation from the backplane, move the jumper to the DIS position. Factory setting is the EN position.

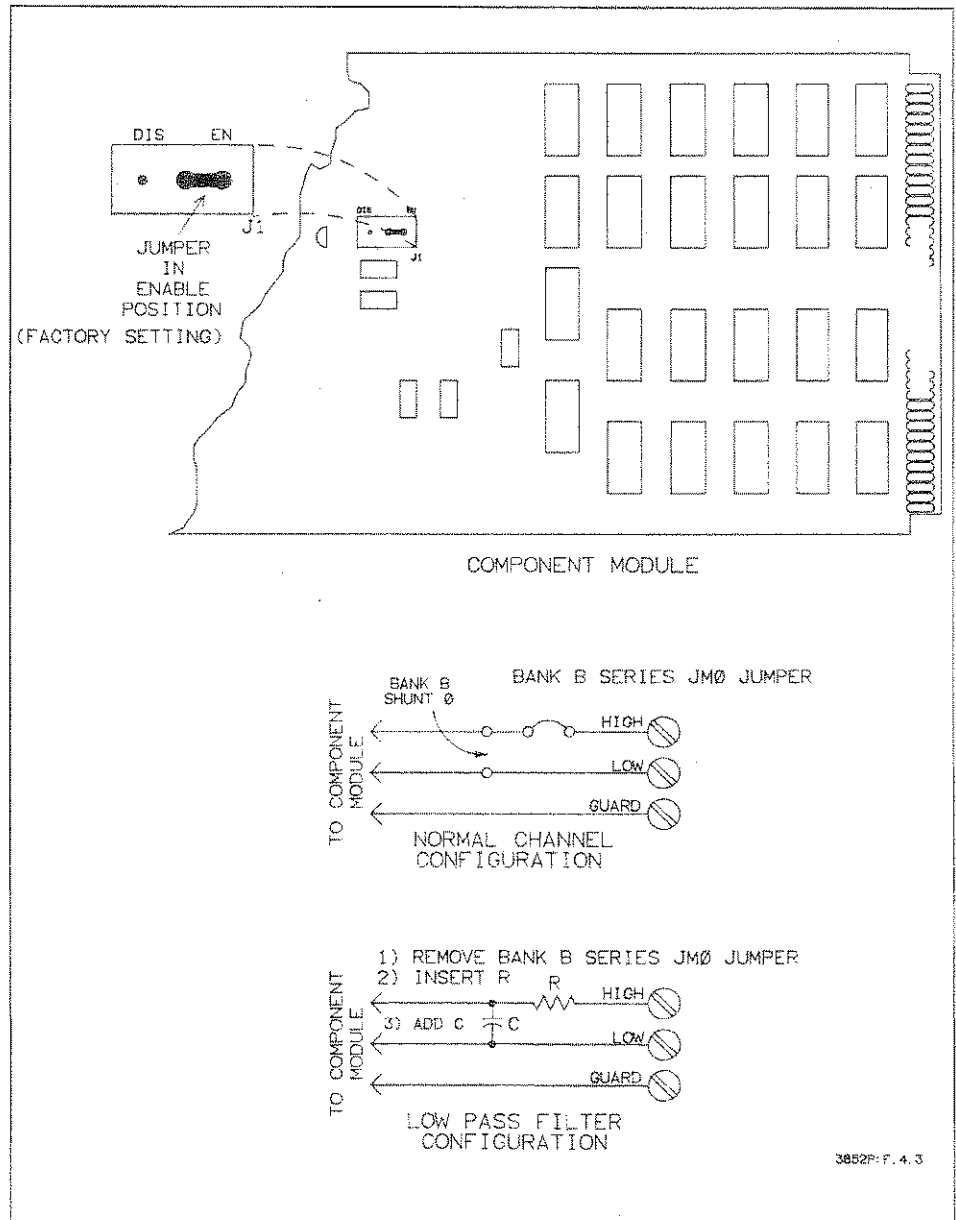

Figure 4-3. HP 44708A/44708H Isolation Jumper Configuration

Low-Pass Filters

Space is provided on the terminal module for you to install low-pass filters for input signal conditioning on each channel. Figure 4-4 shows the normal channel configuration and shows how to install a low-pass filter for channel 10 on the terminal module.

To install the low-pass filter, remove the jumper Bank B SERIES JM0 jumper and install your resistor in its place. Then, install your capacitor in the Bank B SHUNT 0 position as shown.

CH10 LOW PASS FILTER INSTALLATION

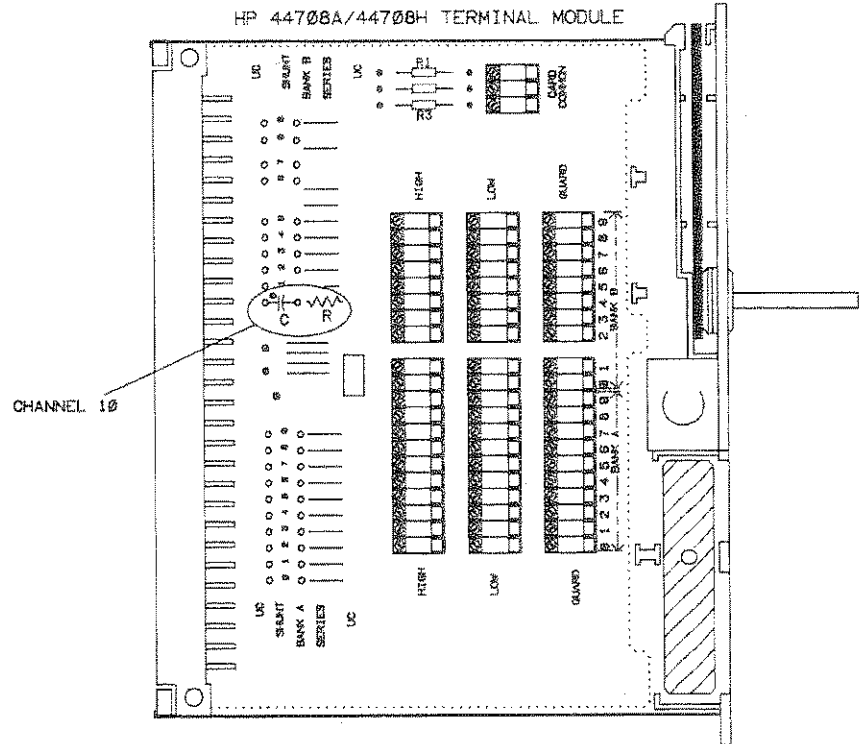

CH10 FILTER CONFIGURATION

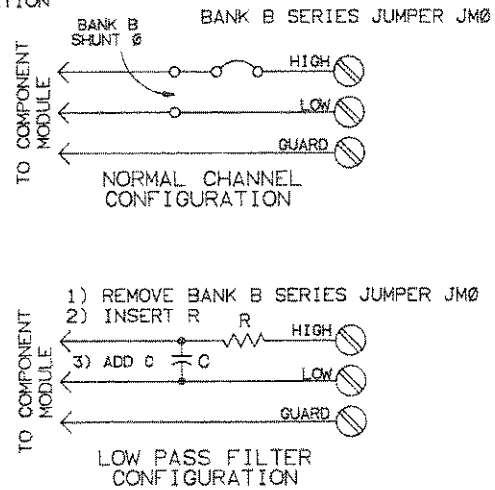

3652P: F. 4. 4

Figure 4-4. HP 44708A/44708H Low-Pass Filter Channel Configuration

Attenuators

The space for low-pass filters on the terminal module can also be used to install attenuators to reduce input signals to a usable level for the HP 44708A or HP 44708H. Figure 4-5 shows normal channel configuration and shows how to install an attenuator for channel 0 on the terminal module. To install the attenuator, remove the Bank A SERIES JMO jumper and install resistor R1 in its place. Then, install resistor R2 in the Bank A SHUNT 0 position as shown. Precision components should be used to maintain accuracy.

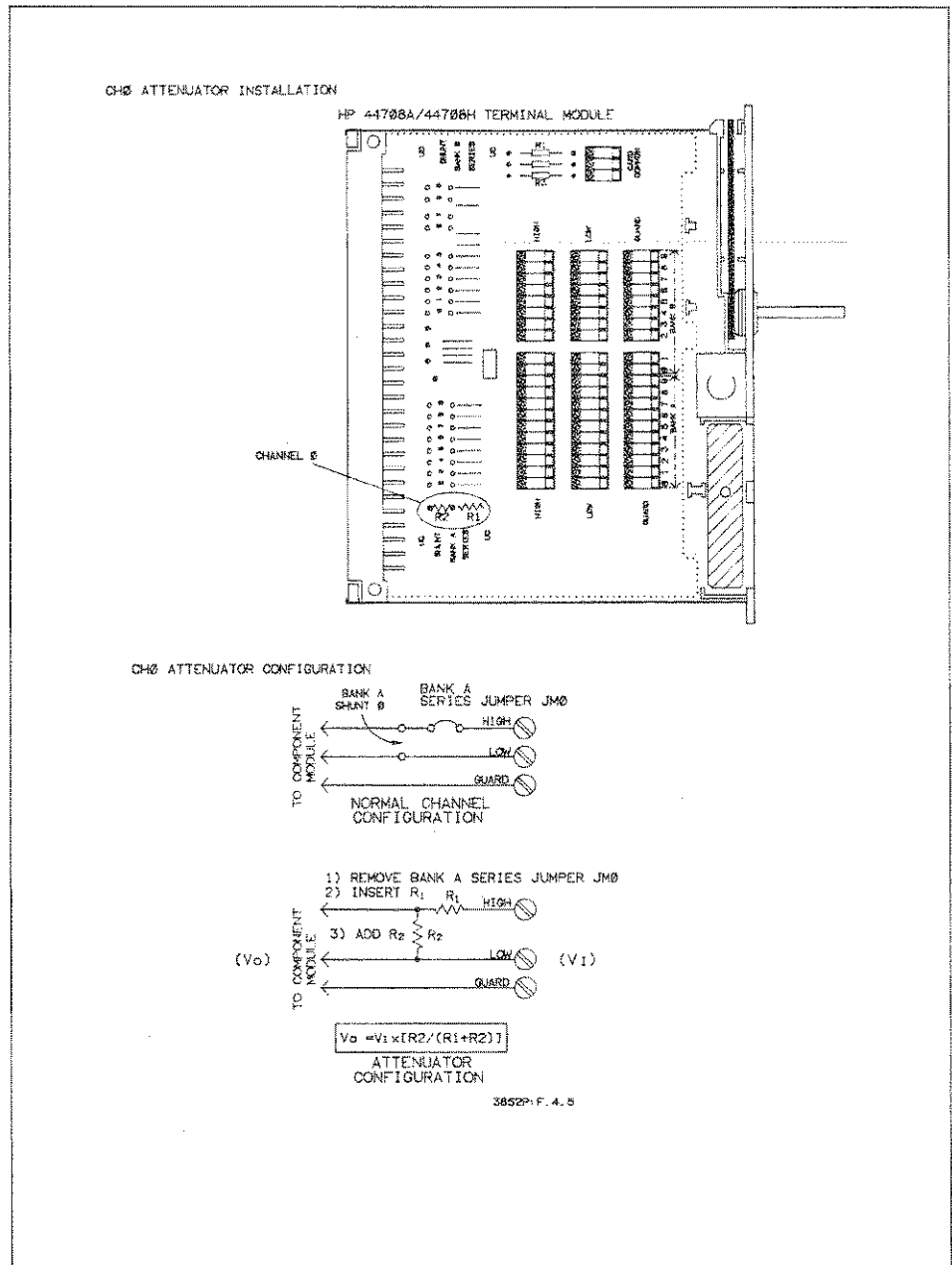

Figure 4-5. HP 44708A/44708H Attenuator Channel Configuration

Current Sensing

The HP 44708A or HP 44708H multiplexers use current sensing to make current measurements. When making a current sensing measurement, the voltage across a shunt resistor is measured and the current is calculated using the measured voltage and the resistance value of the shunt. Precision resistors should be used to maintain accuracy.

Figure 4-6 shows normal channel configuration and shows how to configure channel 0 for current sensing measurements. In Figure 4-6, a 250 Ω shunt resistor (R0) is installed in the shunt position (Bank A SHUNT 0) for channel 0 on the terminal module. Note that the Bank A SERIES JM jumper (JM0 in this example) MUST be in place on the terminal module for each channel being used for current measurements.

NOTE

Current sensing measurements are not recommended when making temperature measurements on the same HP 44708A or HP 44708H terminal module. The heat produced by the shunt resistor may affect the accuracy of the temperature measurements.

CH0 CURRENT SENSING INSTALLATION

HP 44708A/44708H TERMINAL MODULE

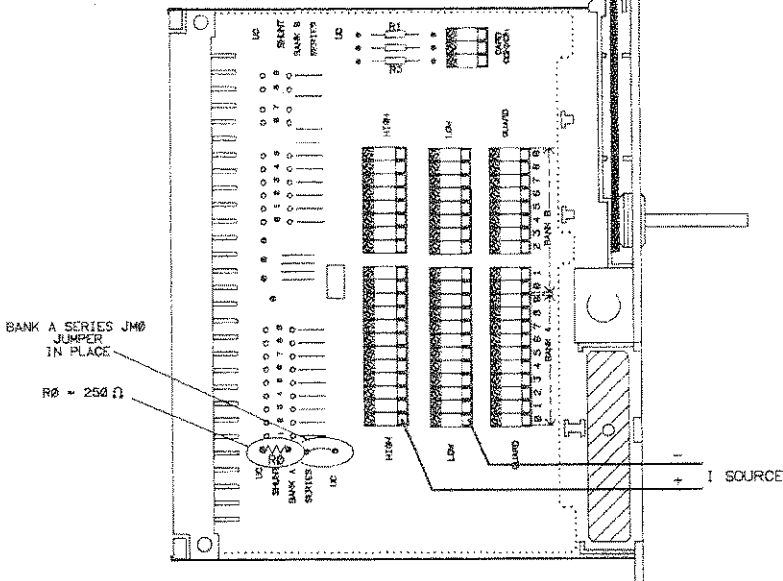

CH0 CURRENT SENSING CONFIGURATION

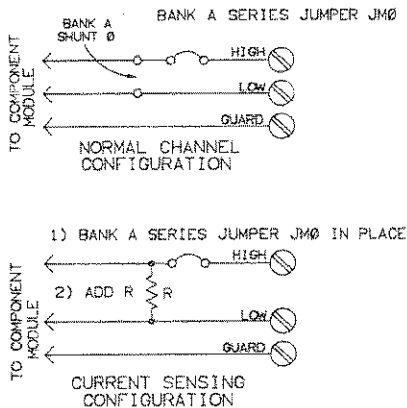

3862P-F, 4, B

Figure 4-6. HP 44708A/44708H Current Sensing Configuration

Field Wiring Connections

When the terminal module is configured as required, the next step is to connect field wiring from your application to the terminals on the terminal module. This section contains example field wiring connections to the terminal module for voltage, resistance (2-wire ohms), and thermocouple measurements.

NOTE

For measurements using the HP 44702A/B High-Speed Voltmeter shielded, twisted-pair cable is required for connections to the terminal module. Shielded, twisted-pair cable suitable for connections to the HP 44708A or HP 44708H multiplexer can be ordered from your nearest Hewlett-Packard Sales and Support Office. Order HP part number 03498-61602 which is a 2 metre shielded, twisted-pair cable with crimped and heat-shrunk wires attached to the braided shield at both ends.

Terminal Module Connections

Figure 4-7 shows the HP 44708A or HP 44708H terminal module with the cover removed. Each of the 20 channels has a HIGH, LOW, and GUARD terminal. Terminals 0 through 9 in Bank A are for channels 0 through 9, respectively. Terminals 0 through 9 in Bank B are for channels 10 through 19, respectively.

When connecting field wiring to the terminal module, route the wires under the strain relief clamp and tighten the clamp screw to reduce the chance of wires being pulled out of the terminal connectors. If the clamp screw is loosened far enough, the strain relief clamp can be rotated to make it easier to route the wiring.

When connecting components such as resistors, the lead length may be too short to route through the strain relief clamp. In this case, the components will have to be stored inside the terminal module. When connecting these components, make sure that no leads are shorted together and bend the leads to allow the terminal module cover to be replaced.

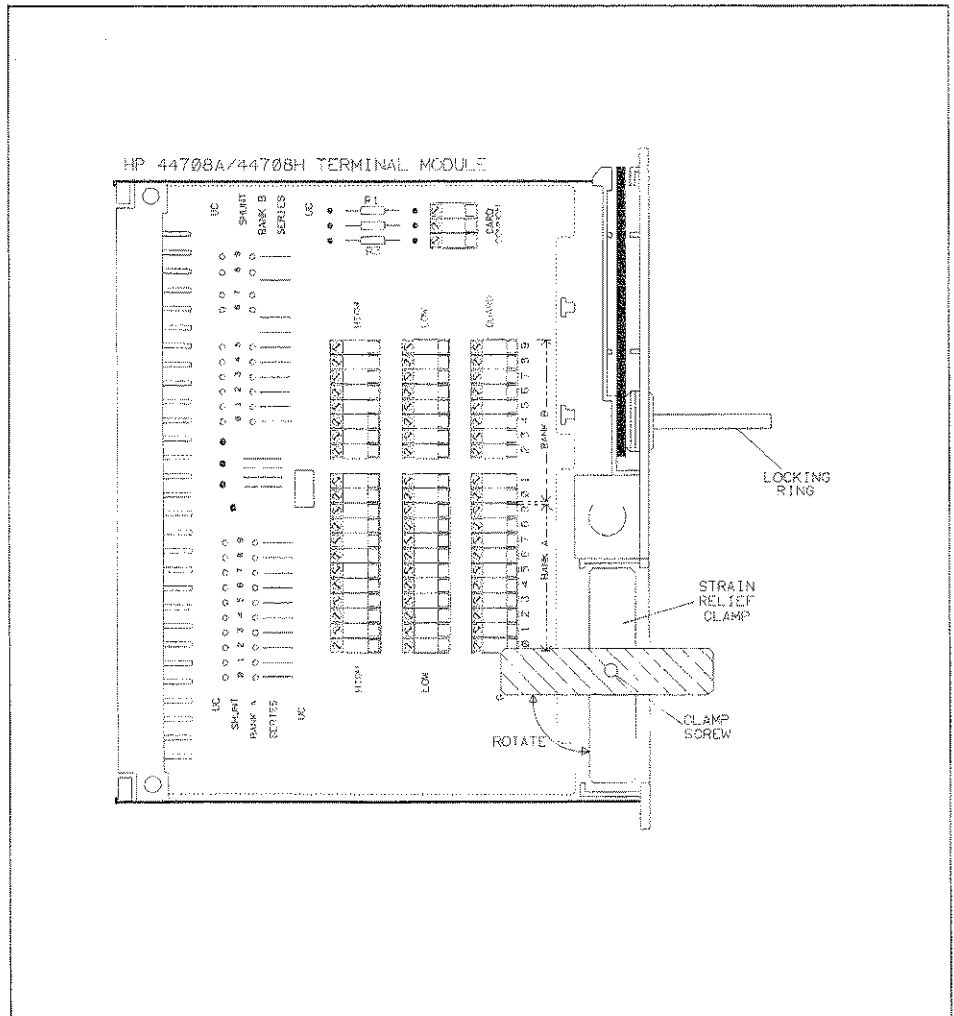

Figure 4-7. HP 44708A/44708H Terminal Module

Voltage Measurements Connections

The HP 44708A or HP 44708H multiplexer can switch signals for up to 20 guarded (3-wire) DC or AC voltage measurements (DC voltage measurements only for the HP 44702A/B High-Speed Voltmeter). With guarded voltage measurements, HIGH, LOW, and GUARD lines are switched on each selected channel for maximum common mode noise rejection.

Figure 4-8 shows typical voltage measurement connections to channel 0 on the terminal module. Connect the HI (+) lead from the voltage source to channel 0 HIGH terminal and the LO (-) lead from the voltage source to the channel 0 LOW terminal. If a guarded (3-wire) voltage measurement is being made, connect the shield from the shielded twisted-pair cable to the channel 0 GUARD terminal.

Resistance Measurements Connections

Since the shielded, twisted-pair cable reduces measurement noise, shielded cable is required for measurements with the HP 44702A/B voltmeter and is highly recommended for measurements with the HP 44701A voltmeter. Also, for the HP 44702A/B voltmeter, an external resistor (R) should be connected between the source voltage LO and the shield, as shown in Figure 4-8.

The HP 44706A accessory can also be used to switch signals for resistance measurements using 2-wire ohms measurement techniques. In applications where the resistance of the test leads is not critical, the 2-wire ohms function can be used. Generally, the larger the resistance being measured, the less you have to be concerned about test lead resistances.

Use the 2-wire ohms function to switch signals for up to 60 resistance measurements per HP 44706A accessory. Figure 3-4 shows typical 2-wire ohms measurement connections for a resistor (R0) connected to channel 0 on the terminal module with shielded, twisted-pair cable.

Shielded cable is required for inputs to the HP 44702A/B voltmeter and is highly recommended for inputs to the HP 44701A voltmeter. In Figure 3-4, note that one end of the shield lead is connected to the LO side of the resistor and the other end of the shield lead is connected to the common GUARD terminal.

For measurements with the HP 44702A/B High-Speed Voltmeter, use $R = 10 \text{ k}\Omega$ to $100 \text{ k}\Omega$. For measurements with the HP 44701A Integrating Voltmeter, make a direct connection from R0 LO to the shield (e.g., $R = 0$).

For measurements with the HP 44701A Integrating Voltmeter ONLY, if shielded cable is not used connect one lead of the resistor to channel 0 HIGH terminal and the other lead of the resistor to common LOW terminal. If high common mode noise rejection is required, also connect a separate lead from resistor R0 LO to the common GUARD terminal.

VOLTAGE MEASUREMENTS

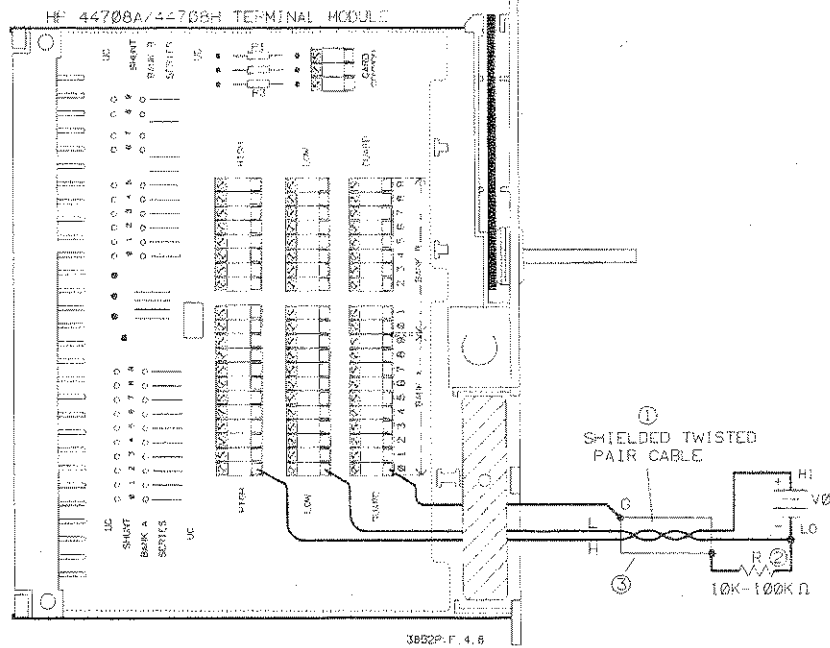

Notes:

- [1] = Shielded cable and external resistor R are required for measurements with the HP 44702A/B High-Speed Voltmeter. Shielded cable is highly recommended for measurements with the HP 44701A Integrating Voltmeter.
- [2] = For measurements with the HP 44702A/B High-Speed Voltmeter, use $R = 10\text{ k}\Omega$ to $100\text{ k}\Omega$. For measurements with the HP 44701A Integrating Voltmeter, make a direct connection from V0 LO to the shield (e.g., $R = 0$).
- [3] = For the HP 44701A Integrating Voltmeter ONLY, if shielded cable is not used connect a lead from V0 HI (+) to channel 0 HIGH, a lead from V0 LO (-) to channel 0 LOW, and a lead from V0 LO to channel 0 GUARD.

Figure 4-8. HP 44708A/44708H Voltage Connections

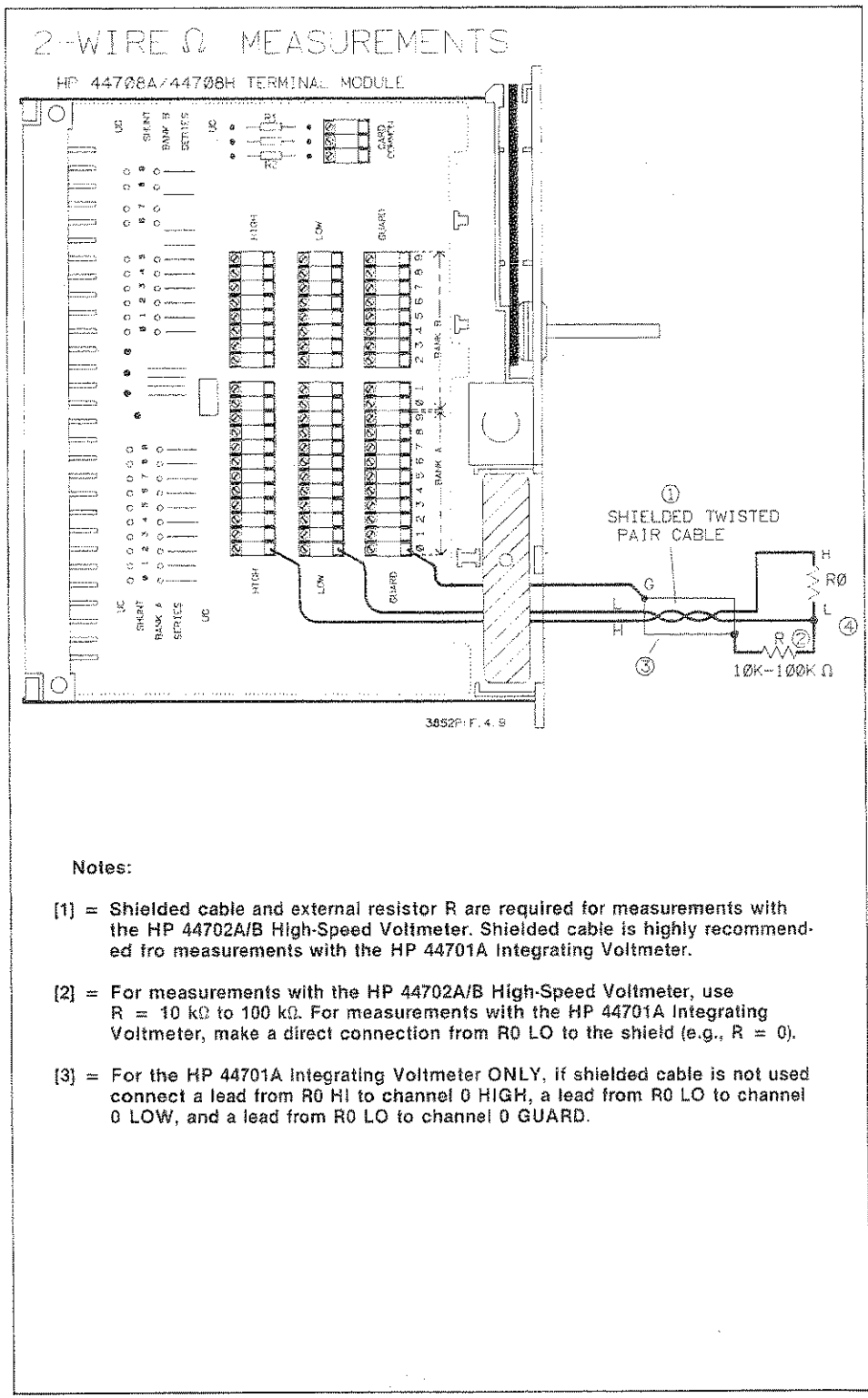

Figure 4-9. HP 44708A/44708H 2-Wire Ohms Connections

Thermocouple Measurements Connections

One of the functions of the HP 44708A or HP 44708H multiplexer is to switch signals for temperature measurements. This section shows how to connect thermocouples to the terminal modules for temperature measurements.

Thermocouples provide a simple, durable, inexpensive, and relatively accurate temperature sensor for a wide variety of applications and environmental conditions. The thermocouple is a junction of two dissimilar metals that produces a voltage related to the junction temperature. Up to 20 thermocouple measurements can be made per HP 44708A or HP 44708H accessory.

Since the channels on the HP 44708A or HP 44708H can be independently configured and software compensation is used, any mixture of thermocouple types can be measured using the multiplexers. Although any thermocouple can be used with the HP 44708A or HP 44708H, the HP 3852A temperature conversions support only B, E, J, K, N14, N28, R, S, and T type thermocouples. Before connecting thermocouples to the terminal module, refer to Table 4-2 for connection guidelines.

Table 4-2. Thermocouple Connection Guidelines

- | |
|--|
| <ol style="list-style-type: none">1. Use the largest thermocouple wire possible that will not shunt significant heat away from the thermocouple area.2. Use thermocouple wire that is well within its rating.3. Avoid mechanical stress and vibration that could strain the wires.4. For long runs, use a shielded, twisted-pair thermocouple extension cable and connect the shield to the GUARD terminal on the terminal module.5. Avoid steep temperature gradients.6. In hostile environments, use proper sheathing material to reduce adverse effects on thermocouple wires. |
|--|

See Figure 4-10 for example thermocouple (TC0) connections to channel 0 on the terminal module. Connect the negative metal lead (red lead) to the LOW terminal on channel 0 and connect the positive metal lead to the HIGH terminal on channel 0. If high common mode noise rejection is required, connect the shield lead from the thermocouple to the GUARD terminal on channel 0. Figure 4-10 also shows three alternate thermocouple wiring configurations.

THERMOCOUPLE CONNECTIONS

HP 44708A/44708H TERMINAL MODULE

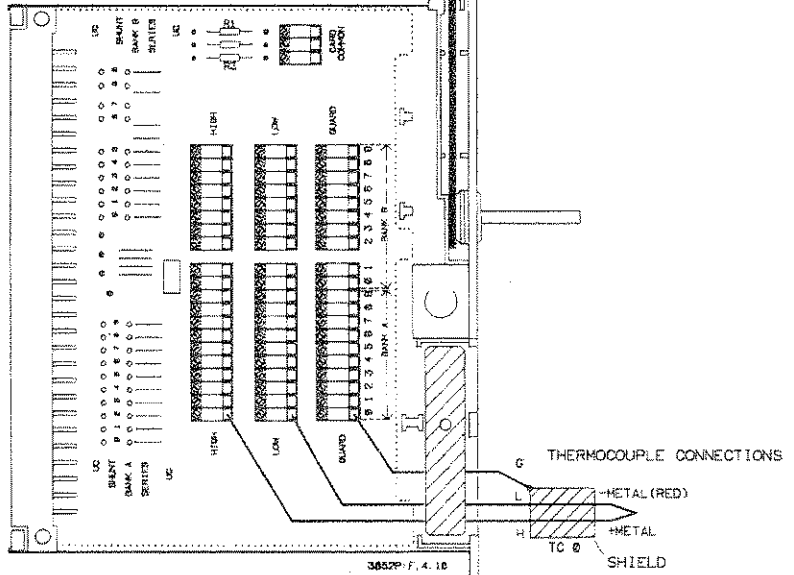

ALTERNATE WIRING METHODS (MEASUREMENTS WITH HP 44701A VOLTMETER)

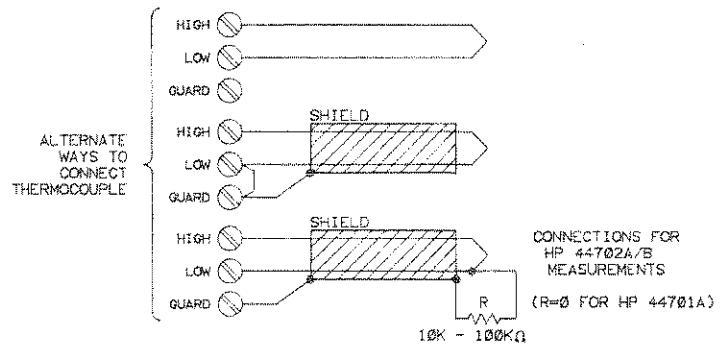

Figure 4-10. HP 44708A/44708H Thermocouple Connections

Installation/Checkout

This section shows how to check the accessory identity, how to verify the field wiring connections, and how to read the state of the channels for the HP 44708A or HP 44708H.

NOTE

The example programs in this manual use "709" as the HP-IB address for the HP 3852A. Specific slot and channel numbers are also used. Program syntax and data return formats apply to HP Series 200/300 Controllers. Modify slot and channel numbers as required.

Check Accessory ID

After you have connected field wiring from your application to the terminal module, replace the terminal module cover and install the accessory in the desired mainframe or extender slot. Refer to the HP 3852A Mainframe Configuration and Programming Manual to connect the terminal module to the component module and to install the accessory.

When the accessory is installed, use the ID? command to check the accessory ID. At power-on, an HP 44708A or HP 44708H returns 44708A, while a component module only (no terminal module attached) returns 447XXX. (Note that if the terminal module is removed after power-on, the accessory still returns 44708A.)

For example, the following program determines the identity of an accessory in slot 2 of the mainframe. An HP 44708A or HP 44708H multiplexer in this slot returns 44708A.

```
10 OUTPUT 709;"ID? 200"      !Query ID in mainframe slot 4
20 ENTER 709;A$              !Enter ID
30 PRINT A$                  !Display ID
40 END
```

If the multiplexer does not return 44708A, be sure you have addressed the correct slot and the terminal module is installed. If these are correct but the correct ID code is not returned, refer to the HP 3852A Assembly Level Service Manual for service procedures.

Verify Wiring Connections

To verify that your field wiring has been properly connected to the terminal module, send the MONMEAS (Monitor/Measure) command from the HP 3852A front panel keyboard or from a controller. This command can be used to check DC or AC voltage and 2-wire ohms connections. An example follows.

This program segment uses the MONMEAS command to verify DC voltage connections on channels 200 through 219 of an HP 44708A or HP 44708H multiplexer in slot 2 of the mainframe. The CONF command configures a voltmeter for DC voltage measurements. The voltmeter is installed in slot 0 of the mainframe.

The 20 channels are to be scanned and measured one at a time starting with channel 200. Press the SADV KEY key on the HP 3852A front panel to advance the scanning to the next channel. When the scan is advanced past the last channel (channel 219 in this example), scanning will stop and the last measurement will remain on the display.

```
10 OUTPUT 709;"USE 0"           !Use voltmeter in mainframe slot 0
20 OUTPUT 709;"CONF DCV"       !Set DC volts function on voltmeter
30 OUTPUT 709;"MONMEAS DCV,200-219" !Monitor/measure ch 200 through 219
40 END
```

Read Channel State

The CLOSE? command can be used to determine the state of the multiplexer channels. This command returns one of five numbers as shown in Table 4-3 for each channel queried. The numbers returned indicate if a channel is open or closed and to which bus (Sense, Source, or both) the channel is connected.

Table 4-3. Values Returned by CLOSE?

Data Returned	Channel State
0	Channel Open
1	Channel Closed - not connected to Bus
2	Channel Closed - connected to Sense Bus
3	Channel Closed - connected to Source Bus
4	Channel Closed - connected to Both Buses

Example: Reading Channel State

This program uses the CLOSE? command to check the state of channels 200 through 204 of an HP 44708A or HP 44708H in slot 2 of the mainframe. The RST (reset) command resets the multiplexer to its power-on state with all channels open. The CLOSE command closes channel 203 and the Sense Bus tree switch (channel 291). The OPEN command opens the channel and disconnects it from the backplane.

```

10 OUTPUT 709;"RST 200"           !Open all chs and isolation relays
20 INTEGER State(0:4)             !Define controller array
30 OUTPUT 709;"CLOSE 203,291"     !Close ch 203, Sense Bus tree switch
40 OUTPUT 709;"CLOSE? 200-204"    !Query state of chs 200 through 204
50 ENTER 709;State(*)             !Enter state
60 PRINT State(*)                 !Display state
70 OUTPUT 709;"OPEN 203,291"     !Open ch 203, Sense Bus tree switch.
80 END

```

For this example, since channel 203 was the only channel closed and was connected to the Sense Bus tree switch, a typical return is:

```
0 0 0 2 0
```

Chapter 5

Programming the HP Multiplexers

Contents

Programming Overview.....	5-1
Chapter Contents.....	5-1
Command Summary.....	5-2
Program Titles.....	5-2
Voltage Measurements.....	5-3
Current Measurements.....	5-7
Resistance Measurements.....	5-9
2-Wire Ohms Measurements.....	5-9
4-Wire Ohms Measurements.....	5-11
Temperature Measurements.....	5-12
RTD Measurements.....	5-12
Thermistor Measurements.....	5-13
Thermocouple Measurements.....	5-14

Programming the Multiplexers

Programming Overview

As noted, the five multiplexers described in this manual have four primary measurement functions: voltage, current, resistance, and temperature. This chapter shows how to program the multiplexers for each measurement function.

Chapter Contents

This chapter includes a description of each measurement function, applicable commands for the function, and programming examples. Each example includes a sample program and typical data returns for assumed conditions.

The chapter also summarizes the programming commands used with the multiplexers (refer to "Command Summary") and lists the titles of the example programs (refer to "Program Titles").

The example programs show how to make typical measurements using the multiplexers with the HP 44701A Integrating Voltmeter or with the HP 44702A/B High-Speed Voltmeter in System Mode. Refer to the HP 3852A Mainframe Configuration and Programming Manual for information on making measurements using an external voltmeter. Refer to the HP 44701A or HP 44702A/B configuration and programming manual for details on programming the voltmeter.

NOTE

The example programs in this manual use "709" as the HP-IB address for the HP 3852A. Specific slot and channel numbers are also used. Program syntax and data-return formats apply to HP Series 200/300 Controllers. Modify slot and channel numbers as required.

Command Summary

Table 5-1 is an alphabetical listing of commands which apply to the multiplexer accessories. Refer to the HP 3852A Command Reference Manual for a complete description of these commands.

Table 5-1. Multiplexer Commands

CLOSE *ch_list*

Closes a single multiplexer channel or a list of channels specified by *ch_list*. This command is intended for individual switch control in special signal-routing applications. It is not the easiest way to do routine measurements since the tree switches are not automatically configured as with high-level commands.

CLOSE? *ch_list* [INTO *name*] or [*fmt*]

Queries the state of channels specified by *ch_list*.

CONF *function* [USE *ch*]

Configure the voltmeter for the function specified by *function*.

CONFMEAS *function ch_list* [NSCAN *number*] [USE *ch*] [INTO *name*] or [*fmt*]

Configures the voltmeter accessory and measures a function specified by *function* on the channels specified by *ch_list*. This command automatically configures the voltmeter accessory and the tree switches on the multiplexer specified for the measurement. (NSCAN applies only to mainframe revision 2.2 and greater.)

ID? [*slot*]

Reads the identity of the accessory in the slot specified by *slot*.

MEAS *function ch_list* [NSCAN *number*] [USE *ch*] [INTO *name*] or [*fmt*]

Scans and measures a function specified by *function* on the channels specified by *ch_list*. This command does not fully configure the voltmeter, but does configure the tree switches on the multiplexer for the measurement. (NSCAN applies only to mainframe revision 2.2 and greater.)

MONMEAS *function ch_list* [USE *ch*]

Monitors and measures a function specified by *function* on the channels specified by *ch_list*. This command is useful to check wiring connections to the terminal module.

OPEN *ch_list*

Opens a single multiplexer channel or a list of channels specified by *ch_list*. This command is used to open channels and place them in a safe state after the measurements have been made.

RST [*slot*]

Resets the accessory in the slot specified by *slot* to its power-on state.

Program Titles

Table 5-2 lists the titles of the example programs in this chapter. Note that all examples do not apply to all multiplexers, but show only typical or recommended measurements for the multiplexers (refer to Table 1-1).

Table 5-2. Example Program Titles

Title	Description	Multiplexer(s)
Voltage Measurements		
Guarded Voltage Measurements	Measure the output from 20 voltage sources.	HP 44705A, ✓ HP 44705H
Single-Ended Voltage Measurements	Measure the output from 60 voltage sources.	HP 44706A
Guarded Voltage Measurements Using CLOSE	Measure the output from a voltage source. Use CLOSE to control tree and bank switches.	HP 44705A, ✓ HP 44705H
Current Measurements		
AC/DC Current Measurements	Make a current sensing measurement using a shunt resistor installed on the terminal module.	HP 44705A, ✓ HP 44705H
Resistance Measurements		
Resistance Measurements (2-Wire Ohms)	Measure 60 resistances using 2-wire ohms measurements.	HP 44706A
Resistance Measurements (2-Wire Ohms) Using CLOSE	Measure a single resistance using 2-wire ohms measurements. Use CLOSE to control tree and bank switches.	HP 44705A, ✓ HP 44705H
Resistance Measurements (4-Wire Ohms)	Measure single resistance using 4-wire ohms measurements.	HP 44705A ✓ HP 44705H
Temperature Measurements		
RTD Measurements	Measure a temperature using an RTD and 4-wire ohms measurements.	HP 44705A, ✓ HP 44705H
Thermistor Measurements	Measure temperature using a thermistor and 4-wire ohms measurements.	HP 44705A, ✓ HP 44705H
Thermocouple Measurements	Make 20 temperature measurements using J-type thermocouples.	HP 44708A, ✓ HP 44708H
Isothermal Block Reference Temperature	Measure the isothermal block (reference) temperature.	HP 44708A, ✓ HP 44708H

Voltage Measurements

One of the functions of the multiplexer accessories is to switch signals for voltage measurements. This section shows how to program the HP 44705A or HP 44705H to make guarded (3-wire) DC and AC voltage measurements using the CONFMEAS and CLOSE commands. It also shows how to use CONFMEAS to make single-ended voltage measurements with the HP 44706A.

Three example programs follow to illustrate AC and DC voltage measurements. The first example uses an HP 44705A or HP 44705H multiplexer and the CONFMEAS command. The second example uses an HP 44706A multiplexer and the CONFMEAS command. The third example uses an HP 44705A or HP 44705H multiplexer and the CLOSE command.

NOTE

The AC voltage function is considerably slower than the DC voltage function. It takes approximately two seconds for the HP 44701A Integrating Voltmeter to configure for AC voltage measurements and approximately 1.5 seconds per reading. Note that the HP 44702A/B High-Speed Voltmeter cannot be used to make AC voltage measurements.

Example: Guarded Voltage Measurements

This example uses the CONFMEAS command to measure the outputs from 20 voltage sources connected to an HP 44705A or HP 44705H multiplexer. See Figure 2-8 to connect voltage sources to the HP 44705A or HP 44705H terminal module.

This program measures 20 DC voltage sources connected to channels 200 through 219 of the multiplexer installed in slot 2 of the mainframe using a voltmeter installed in slot 0 of the mainframe. The CONFMEAS command configures the voltmeter accessory for DC voltage measurements and measures the 20 channels once.

NOTE

To use the program to make AC voltage measurements with the HP 44701A Integrating Voltmeter, substitute the following line for the existing line 30:

```
30 OUTPUT 709;"CONFMEAS ACV,200-219"
```

10 DIM Volts(0:19)	!Define controller array
20 OUTPUT 709;"USE 0"	!Use voltmeter in mainframe slot 0
30 OUTPUT 709;"CONFMEAS DCV,200-219"	!Set DC volts, meas ch 200-219
40 ENTER 709;Volts(*)	!Enter 20 readings
50 PRINT USING "K,/" ;Volts(*)	!Display 20 readings
60 END	

For a set of 5 V 5% inputs, a typical return is:

4.993	} 20 readings
4.9935	
...	
4.9947	

Example: Single-Ended Voltage Measurements

This example uses the CONFMEAS command to measure the outputs from 60 voltage sources connected to an HP 44706A multiplexer. See Figure 3-3 to connect voltage sources to the HP 44706A terminal module.

This program uses the CONFMEAS command to measure 60 DC voltage sources connected to channels 200 through 259 of the multiplexer installed in slot 2 of the mainframe using a voltmeter installed in slot 0 of the mainframe. The CONFMEAS command configures the voltmeter accessory for DC voltage measurements and measures the 60 channels once.

NOTE

To use the program to make AC voltage measurements with the HP 44701A Integrating Voltmeter Accessory, substitute the following line for the existing line 30:

30 OUTPUT 709;"CONFMEAS ACV,200-259"

10 DIM Volts(0:59)	!Dimension controller array
20 OUTPUT 709;"USE 0"	!Use voltmeter in mainframe slot 0
30 OUTPUT 709;"CONFMEAS DCV,200-259"	!Set DC volts, meas ch 200-259
40 ENTER 709;Volts(*)	!Enter 60 readings
50 PRINT USING "K,/";Volts(*)	!Display 60 readings
60 END	

For a set of 5 V 5% inputs, a typical return is:

```

4.93
4.995
.
.
.
4.974
  
```

} 60 readings

Example: Guarded Voltage Measurements Using CLOSE

This example uses the CLOSE command to measure the output from a voltage source connected to channel 200 of an HP 44705A or HP 44705H in slot 2 of the mainframe. See Figure 2-8 to connect voltage sources to the HP 44705A or HP 44705H terminal module.

CAUTION

The CLOSE command does not close channels in a break-before-make fashion. Therefore, the command can and will cause damage to the multiplexer accessory (relay or FET) and external system if it is used to force one channel open by closing another. This applies to channels in the same bank, in separate banks tied together by the tree relays, and to the tree relays themselves.

Before a channel is closed with the CLOSE command, use the OPEN command to open the channel that is currently closed. This prevents any two channels from being closed at the same time and reduces the risk of damaging your equipment.

NOTE

The CLOSE command is a low-level command intended for individual switch control in special signal-routing applications. It is not the easiest way to do routine measurements since the tree switches are not automatically configured as with the high-level commands.

In the following program, CLOSE closes the measurement channel (channel 200) and the Bank A Sense Bus tree switch (channel 291) for the multiplexer, CONF configures the voltmeter for DC voltage measurements, TRIG triggers the voltmeter to take a single measurement, and CHREAD sends the reading from the voltmeter to the output buffer. OPEN opens the channel and disconnects it from the backplane after the measurement has been taken.

NOTE

To use the following program to make an AC voltage measurement with the HP 44701A Integrating Voltmeter, substitute the following line for the existing line 30:

```
30 OUTPUT 709;"CONF ACV"
```

10 OUTPUT 709;"USE 0"	!Use voltmeter in mainframe slot 0
20 OUTPUT 709;"CLOSE 200,291"	!Close ch 200, Sense Bus tree switch
30 OUTPUT 709;"CONF DCV"	!Set DC volts
40 OUTPUT 709;"TRIG SGL"	!Trigger voltmeter
50 OUTPUT 709;"CHREAD 0"	!Transfer reading to output buffer
60 ENTER 709;A	!Enter reading
70 PRINT A	!Display reading
80 OUTPUT 709;"OPEN 200,291"	!Open ch 200, Sense Bus tree switch
90 END	

A typical return from a 5 V 5% input is:

4.987

Current Measurements

The HP 44705A, HP 44705H, HP 44708A, and HP 44708H multiplexers use current sensing to make current measurements. When making a current sensing measurement, the voltage across the shunt resistor is measured and the current is calculated in the controller using the measured voltage and the resistance of the shunt. This section shows how to program the HP 44705A or HP 44705H to make DC and AC current measurements.

NOTE

Current sensing measurements are not recommended when making temperature measurements on the same HP 44708A or HP 44708H terminal module since the heat produced by the shunt resistor may affect the accuracy of the temperature measurements.

NOTE

The AC voltage function (used for AC current sensing) is considerably slower than the DC voltage function. It takes approximately two seconds for the HP 44701A Integrating Voltmeter to configure for AC voltage measurements and approximately 1.5 seconds per reading. Note that the HP 44702A/B High-Speed Voltmeter cannot be used to make AC current measurements.

An example follows to show how to make DC current measurements on channel 200 of an HP 44705A or HP 44705H in slot 2 of the mainframe when a 250 Ω shunt resistor is installed on the channel.

Example: AC/DC Current Measurements

The following program uses the CONFMEAS command to measure DC voltage across a 250 Ω shunt resistor installed on channel 200 of an HP 44705A or HP 44705H in slot 2 of the mainframe. The CONFMEAS command configures the voltmeter for DC voltage measurements and measures the channel once. The equivalent DC current value is computed in the controller by using $\text{Current} = \text{Volts}/250$ (see line 40). See Figure 2-6 to install a shunt resistor on the HP 44705A or HP 44705H terminal module for current measurements.

NOTE

To use the following program to make AC current measurements with the HP 44701A Integrating Voltmeter, substitute the following line for the existing line 20:

```
20 OUTPUT 709;"CONFMEAS ACV,200"
```

10 OUTPUT 709;"USE 0"	!Use voltmeter in mainframe slot 0
20 OUTPUT 709;"CONFMEAS DCV,200"	!Set DC volts, measure ch 200
30 ENTER 709;Volts	!Enter DC voltage value
40 PRINT Volts/250	!Display DC current value = Volts/250
50 END	

If a 250 Ω 5% resistor is used, a typical return from a 4-20 mA current loop which is outputting 10 mA (value in Amps) is:

.01004

Resistance Measurements

This section shows how to make 2-wire ohms resistance measurements using the CONFMEAS and CLOSE commands and shows how to make 4-wire ohms resistance measurements using the CONFMEAS command with the HP 44705A or HP 44705H multiplexer. (Recall that the HP 44706A, HP 44708A, or HP 44708H cannot be used for 4-wire ohms measurements.)

2-Wire Ohms Measurements

This section shows how to program the HP 44705A, HP 44705H, or HP 44706A for 2-wire ohms resistance measurements. For applications where the resistance of the test leads is not critical, the 2-wire ohms function can be used. Generally, the larger the resistance being measured, the less you have to be concerned about test lead resistances. Use the 2-wire ohms function to make up to 20 resistance measurements per HP 44705A or HP 44705H accessory or up to 60 resistance measurements per HP 44706A.

Example: Resistance Measurements (2-Wire Ohms)

This example uses the CONFMEAS command to measure 60 resistors connected to an HP 44706A in slot 3 of the mainframe using the 2-wire ohms function. See Figure 3-4 to connect resistors to the terminal module.

The following program uses the CONFMEAS command to measure 60 resistors connected to channels 300 through 359 of an HP 44706A multiplexer in slot 3 of the mainframe. The CONFMEAS command configures the voltmeter accessory for 2-wire ohms measurements and measures each of the 60 channels once.

10 DIM Ohms(0:59)	!Dimension controller array
20 OUTPUT 709;"USE 0"	!Use voltmeter in mainframe slot 0
30 OUTPUT 709;"CONFMEAS OHM,300-359"	!Set 2-wire ohms, meas ch 300-359
40 ENTER 709;Ohms(*)	!Enter 60 readings
50 PRINT USING "K,/" ;Ohms(*)	!Display 60 readings
60 END	

For a set of 5 k Ω 5% resistors, a typical return (values in Ohms) is:

4928.34	}	60 readings
5024.9		
.		
.		
.		
5008.38		

Example: Resistance Measurements (2-Wire Ohms) Using CLOSE

This example uses the CLOSE command to make a 2-wire ohms measurement of a resistor connected to channel 300 of an HP 44705A or HP 44705H multiplexer in slot 3 of the mainframe. See Figure 2-9 to connect resistors to the terminal module.

CAUTION

The CLOSE command does not close channels in a break-before-make fashion. Therefore, the command can and will cause damage to the multiplexer accessory (relay or FET) and external system if it is used to force one channel open by closing another. This applies to channels in the same bank, in separate banks tied together by the tree relays, and to the tree relays themselves.

Before a channel is closed with the CLOSE command, use the OPEN command to open the channel that is currently closed. This prevents any two channels from being closed at the same time and reduces the risk of damaging your equipment.

NOTE

The CLOSE command is a low-level command intended for individual switch control in special signal-routing applications. It is not the easiest way to do routine measurements since the tree switches are not automatically configured as with the high-level commands.

In the program, CLOSE is used to close the measurement channel (channel 300), the Bank A Sense Bus tree switch (channel 391), and the Bank A Source Bus tree switch (channel 393). CONF configures the voltmeter accessory for 2-wire ohms measurements, TRIG triggers the voltmeter to take a single measurement, and CHREAD transfers the resistance value from the voltmeter to the output buffer. OPEN is used to open the channel and disconnect it from the backplane after the measurements have been taken.

```

10 OUTPUT 709;"USE 0"           !Use voltmeter in mainframe slot 0
20 OUTPUT 709;"CLOSE 300,391,393" !Close ch and tree switches
30 OUTPUT 709;"CONF OHM"       !Configure for 2-wire ohms
40 OUTPUT 709;"TRIG SGL"       !Trigger the voltmeter
50 OUTPUT 709;"CHREAD 0"       !Transfer reading to output buffer
60 ENTER 709;A                 !Enter reading
70 PRINT A                     !Display reading
80 OUTPUT 709;"OPEN 300,391,393" !Open ch and tree switches
90 END

```

For a 5 k Ω 5% resistor connected to the channel, a typical return (value in ohms) is:

4982.4

4-Wire Ohms Measurements

Using 4-wire ohms measurements virtually eliminates the error caused by the test lead resistances. The current through the unknown resistance is the same regardless of the lead resistance, but the voltmeter measures only the voltage across the unknown resistance, not across the combined test lead resistance and the unknown resistance.

The 4-wire ohms function is essential when highest accuracy is required. Since each 4-wire ohms measurement requires two channels, up to ten resistance measurements can be made per HP 44705A or HP 44705H accessory. (Note that 4-wire ohms measurements cannot be made with the HP 44706A, HP 44708A, or HP 44708H.) An example follows.

Example: Resistance Measurements (4-Wire Ohms)

This example uses the CONFMEAS command to measure the resistance connected to channel 300 of an HP 44705A or HP 44705H in slot 3 of the mainframe using the 4-wire ohms function. See Figure 2-10 to connect the resistor to the terminal module for 4-wire ohms measurements.

The program uses the CONFMEAS command to measure a resistor using the 4-wire ohms function. Channel 300 is used as the voltage Sense channel and channel 310 as the current Source channel.

Note that the channel specified by the CONFMEAS *ch_list* parameter (channel 300) is designated as the Sense channel. The mainframe then automatically configures the channel one decade away from the Sense channel as the Source channel. The Sense channel is scanned once by the voltmeter and the result (in Ohms) is returned to the controller.

```
10 OUTPUT 709;"USE 0"           !Use voltmeter in mainframe slot 0
20 OUTPUT 709;"CONFMEAS OHMF,300" !Config for 4-wire ohms, meas ch 300
30 ENTER 709;A                 !Enter resistance value
40 PRINT A                     !Display resistance value
50 END
```

For a 5 k Ω 5% resistor connected to the channel, a typical return (value in Ohms) is:

4982.4

Temperature Measurements

This section shows how to program the HP 44705A or HP 44705H for RTD and thermistor measurements and shows how to program the HP 44708A or HP 44708H multiplexers for thermocouple and isothermal block (reference temperature) measurements.

RTD Measurements

The resistance temperature detector (RTD) is a temperature-sensitive resistor that is typically stable, accurate, and linear. The HP 3852A resistance-to-temperature conversions support Type 85 and Type 92 RTDs (temperature coefficients (α) of 0.00385 $\Omega/\Omega/^\circ\text{C}$ and 0.003916 $\Omega/\Omega/^\circ\text{C}$ respectively, and resistance values of 100 Ω at 0 $^\circ\text{C}$).

Most RTDs have small resistance values (typically less than 300 Ω) which makes the test lead resistance a significant factor when making resistance measurements. Thus, the most accurate RTD measurement method is the 4-wire ohms measurement function. Since each 4-wire ohms measurement requires two channels, a single HP 44705A or HP 44705H accessory can be used to make up to ten RTD measurements. An example program follows.

Example: RTD Measurements

This example uses the CONFMEAS command to make a temperature measurement using a Type 92 RTD and the 4-wire function. See Figure 2-10 to connect an RTD to the terminal module for 4-wire temperature measurements.

The following program uses the CONFMEAS command to scan and measure a Type 92 RTD ($\alpha = 0.003916 \Omega/\Omega/^\circ\text{C}$) connected to channel 200 of an HP 44705A or HP 44705H in slot 2 of the mainframe using the 4-wire ohms function. Channel 200 is used as the voltage Sense channel and channel 210 as the current Source channel.

Note that the channel specified by the CONFMEAS *ch_list* parameter (channel 200) is designated as the Sense channel. The mainframe then automatically configures the channel one decade away from the Sense channel as the Source channel. The Sense channel is scanned once by the voltmeter and the result (in $^\circ\text{C}$) is returned to the controller.

```
10 OUTPUT 709;"USE 0"           !Use voltmeter in mainframe slot 0
20 OUTPUT 709;"CONFMEAS RTDF92,200" !Conf for type 92 RTD, meas ch 200
30 ENTER 709;Temp               !Enter temperature
40 PRINT Temp                   !Display temperature
50 END
```

A typical return (value in $^\circ\text{C}$) for an RTD at room temperature is:

24.54297

Thermistor Measurements

Thermistors are capable of detecting small changes in temperature and are used in applications where temperature extremes are not too high. They are highly dependent upon variables such as thermistor composition and size. Most thermistors have negative temperature coefficients which means that their resistance values decrease with increasing temperature.

The HP 3852A allows thermistors to be measured using the 4-wire function. Since each 4-wire measurement requires two channels, up to ten thermistors can be measured per HP 44705A or HP 44705H accessory. The HP 3852A resistance-to-temperature conversions support Type 2252, 5K, and 10K thermistors (resistance values at 25°C of 2252 Ω , 5 k Ω , and 10 k Ω , respectively). An example program follows.

Example: Thermistor Measurements

This example uses the CONFMEAS command to make a 4-wire temperature measurement using a Type 2252 thermistor connected to channel 200 of an HP 44705A or HP 44705H in slot 2 of the mainframe. See Figure 2-10 to connect a thermistor to the terminal module for a 4-wire temperature measurement.

The following program uses CONFMEAS to scan and measure a Type 2252 thermistor using the 4-wire ohms function. Channel 200 is used as the voltage Sense channel and channel 210 as the current Source channel.

Note that the channel specified by the CONFMEAS *ch_list* parameter (channel 200) is designated as the Sense channel. The HP 3852A automatically configures the channel that is one decade away from the Sense channel as the Source channel. The Sense channel is scanned once by the voltmeter and the result (in °C) is returned to the controller.

```
10 OUTPUT 709;"USE 0"           !Use voltmeter in mainframe slot 0
20 OUTPUT 709;"CONFMEAS THMF2252,200" !Conf for thermistor, meas ch 200
30 ENTER 709;Temp              !Enter temperature
40 PRINT Temp                  !Display temperature
50 END
```

For a thermistor at room temperature, a typical return (value in °C) is:
24.69674

Thermocouple Measurements

Thermocouples provide a simple, durable, inexpensive, and relatively accurate temperature sensor for a wide variety of applications and environmental conditions. The thermocouple is a junction of two dissimilar metals which produces a voltage related to the junction temperature. Up to 20 thermocouple measurements can be made per HP 44708A or HP 44708H accessory. The HP 3852A temperature conversions support B, E, J, K, N14, N28, R, S, and T type thermocouples.

The HP 3852A does not directly measure the temperature of thermocouples, but measures the voltages generated by the thermocouples. The measured voltage is a function of the actual temperature of the thermocouples.

The problem with this approach is that the voltage measured by the HP 3852A is different from the actual thermocouple voltage (due to junction voltages on the terminal module) unless some compensating technique is used. The HP 3852A uses a technique called software compensation. In performing software compensated thermocouple measurements, the steps shown in Table 5-3 occur.

Table 5-3. Thermocouple Software Compensation Steps

1. Measure the resistance of the thermistor mounted on the isothermal connector block and compute the isothermal block reference temperature (T_{ref}).
2. Measure the voltage produced by the thermocouple system (V_t).
3. Convert the isothermal block reference temperature (T_{ref}) to a thermocouple reference voltage (V_{ref}). Since the thermocouple reference voltage depends upon the type of thermocouple being compensated, the value returned for V_{ref} will be different for each type of thermocouple. Thus, different thermocouple types can be used on the same accessory.
4. Compute the absolute value of V_t (step 2) - V_{ref} (step 3). That is, $V = |V_t - V_{ref}|$
5. Convert V computed in step 4 to an equivalent temperature in $^{\circ}C$.

NOTE

1. *When used with high-level commands (CONFMEAS for example), the HP 3852A automatically performs the compensation steps when making thermocouple measurements. However, when low-level commands such as CLOSE and OPEN are used, the compensation steps are not performed automatically.*
 2. *Since channels on the HP 44708A or HP 44708H can be independently configured and software compensation is used, any mixture of thermocouple types can be measured. However, separate commands must be executed for each type of thermocouple.*
-

Example: Thermocouple Measurements

This example uses the CONFMEAS command to make 20 temperature measurements using J-type thermocouples connected to channels 200 through 219 of an HP 44708A or HP 44708H in slot 2 of the mainframe. See Figure 4-10 to connect thermocouples to the terminal module for temperature measurements.

The following program uses the CONFMEAS command to measure 20 J-type thermocouples connected to channels 200 through 219 of an HP 44708A or HP 44708H in slot 2 of the mainframe. The program scans the 20 channels once and returns the results (in $^{\circ}C$) to the controller.

```

10 DIM Temp(0:19)                !Define controller array
20 OUTPUT 709;"USE 0"            !Use voltmeter in mainframe slot 0
30 OUTPUT 709;"CONFMEAS TEMPJ,200-219" !Conf for J-type t-couple, meas ch
40 ENTER 709;Temp(*)            !Enter 20 temperature readings
50 PRINT USING "K,/";Temp(*)    !Print readings
60 END

```

For thermocouples at room temperature, a typical return (values in °C) is:

```

24.542
24.5415
.
.
.
25.856

```

} 20 readings

Example: Isothermal Block Reference Temperature

The HP 3852A linearization program supports B, E, J, K, N14, N28, R, S, and T type thermocouples. However, if you want to use a different type of thermocouple for temperature measurements, you will need to measure the reference temperature (isothermal block temperature) to use in your own linearization program. The following example shows how to measure the reference temperature of an HP 44708A or HP 44708H in slot 2 of the mainframe.

This example measures the temperature (the reference temperature) of the thermistor mounted on the isothermal connector block using the CONFMEAS command.

```

10 OUTPUT 709;"USE 0"            !Use voltmeter in mainframe slot 0
20 OUTPUT 709;"CONFMEAS REFT,200" !Meas ref temp in mainframe slot 2
30 ENTER 709;Reftemp            !Enter ref temp
40 PRINT Reftemp                !Display ref temp
50 END

```

For an HP 44708A or HP 44708H at room temperature, a typical return (value in °C) is:

24.438

Index

- A**
- AC current
 - example programs, 5-7
 - measurement connections, 2-8, 3-6, 4-11
 - AC voltage
 - example programs, 5-3
 - measurement connections, 2-13, 3-6, 4-14
 - Attenuators, installing, 2-8, 4-10
- B**
- Bank switches, 2-5, 3-4, 4-5
 - Block diagram description, 2-4, 3-2, 4-4
- C**
- Capabilities, 1-5
 - Channel definitions, 2-6, 3-4, 4-6
 - CLOSE, 2-21, 3-12, 4-21
 - CLOSE?, 2-21, 3-12, 4-21
 - Command summary, 5-2
 - Connections
 - current, 2-8, 4-11
 - resistance, 2-14, 3-9, 4-15
 - temperature, 2-19
 - voltage, 2-13, 3-6, 4-14
 - Current
 - connections, 2-8, 4-11
 - example programs, 5-7
 - sensing, 2-8, 4-11
- D**
- DC current
 - example programs, 5-7
 - measurement connections, 2-8, 4-11
 - DC voltage
 - example programs, 5-3
 - measurement connections, 2-13, 3-6, 4-14
- F**
- Four-wire ohms
 - example programs, 5-11
 - measurement connections, 2-17
- I**
- ID?, 2-20, 3-11, 4-20
 - Identity, checking, 2-20, 3-11, 4-20
 - Installation/checkout
 - HP 44705A/05H, 2-20
 - HP 44706A, 3-11
 - HP 44708A/08H, 4-20
 - Installing
 - attenuators, 2-8, 4-10
 - low-pass filters, 2-8, 4-8
 - shunt resistors, 2-8, 4-11
 - Introduction, 1-1
 - Isolation jumpers, 2-7, 4-7
- L**
- Low-pass filters, installing, 2-8, 4-11
- M**
- Making Measurements
 - AC current, 5-4
 - AC voltage, 5-4
 - DC current, 5-4
 - DC voltage, 5-4
 - Four-wire ohms, 5-11
 - RTDs, 5-12
 - Thermistors, 5-13
 - Thermocouples, 5-14
 - Two-wire ohms, 5-9
- R**
- Reading channel state, 2-21, 3-12, 4-21
 - Resistance
 - example programs, 5-9
 - measurement connections, 2-14, 3-9, 4-15
 - RTDs
 - example programs, 5-12
 - measurement connections, 2-19
- S**
- Shunt resistors, installing, 2-8, 4-11
 - Strain relief, 2-12, 3-6, 4-13
- T**
- Temperature
 - example programs, 5-12
 - measurement connections, 2-19
 - Thermistors
 - example programs, 5-13
 - measurement connections, 2-19
 - Thermocouples
 - example programs, 5-14
 - measurement connections, 4-18
 - Tree switches, 2-5, 3-4, 4-5
 - Two-wire ohms
 - example programs, 5-9
 - measurement connections, 2-14, 3-9, 4-15
- V**
- Verifying wiring connections, 2-21, 3-12, 4-21
 - Voltage
 - example programs, 5-3
 - measurement connections, 2-13, 3-6, 4-14

THE
C
E
A
C
E
D
I
E
L

